

HIRSCHMANN

PAT

LOAD MOMENT INDICATOR

DS 85/0002

central unit/ console

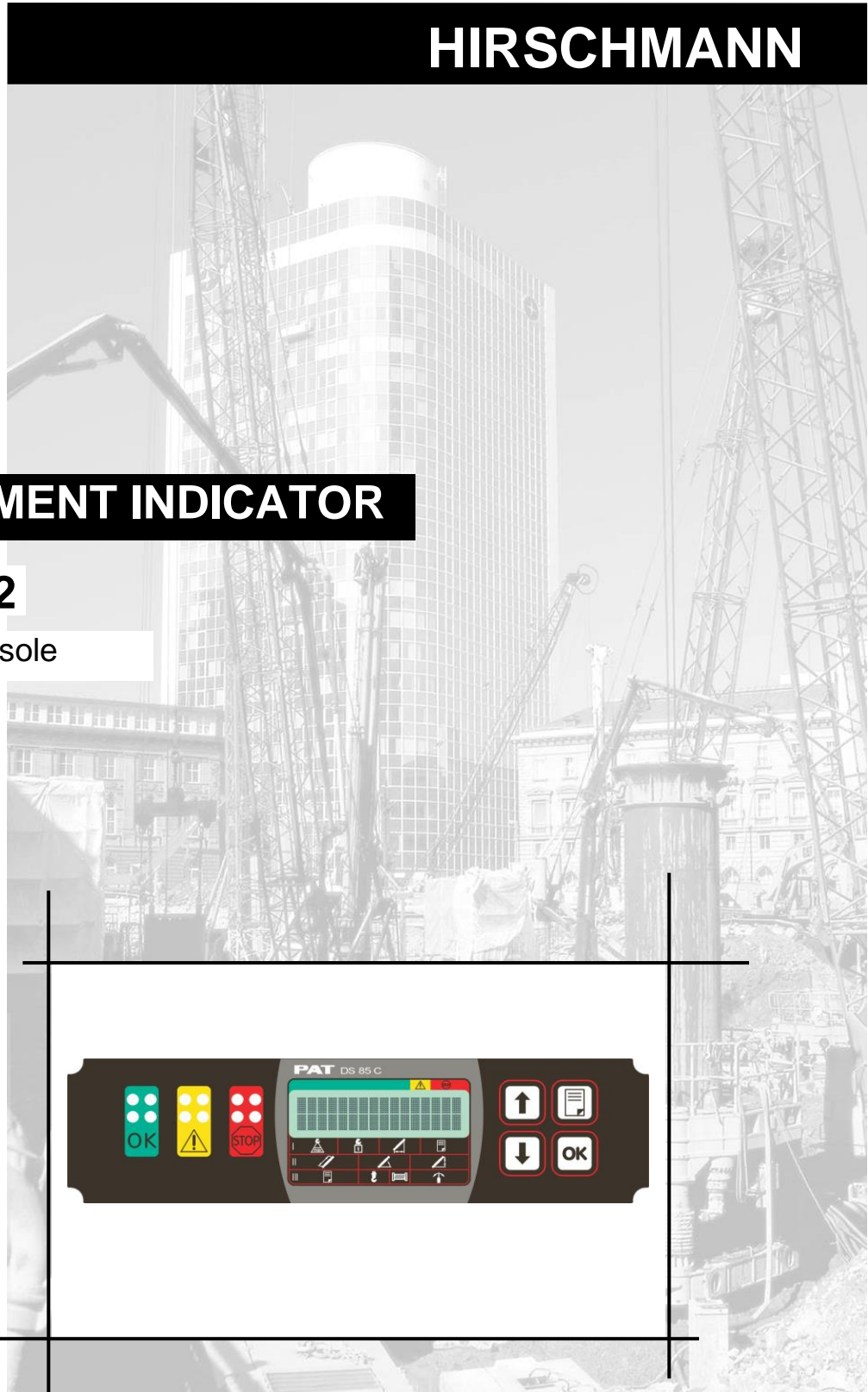

SERVICE MANUAL

P/N 031-300-190-166 REV G 10/05/2015

NOTICE

Hirschmann makes no warranty of any kind with regard to this material, including, but not limited to, the implied warranties of merchantability and/or its fitness for a particular purpose.

Hirschmann will not be liable for errors contained in this manual or for incidental or consequential damages in connection with the furnishing, performance, or use of this manual. This document contains proprietary information, which is protected by copyright, and all rights are reserved.

No part of this document may be photocopied, reproduced, or translated to another language without the prior written consent of Hirschmann.

Hirschmann reserves proprietary rights to all drawings, photos and the data contained therein. The drawings, photos and data are confidential and cannot be used or reproduced without the written consent of Hirschmann. The drawings and/or photos are subject to technical modification without prior notice.

All information in this document is subject to change without notice.

MANUAL REVISIONS

REV	DATE	NAME	DESCRIPTION
-	04/04/03	CSH	ECN 03-039
A	06/20/03	CSH	ECN 03-079
B	07/21/03	CSH	ECN 03-079
C	07/07/04	SB	ECN 04-032
D	09/20/04	SB	ECN 04-176
E	06/16/05	SB	ECN 05-109
F	12/26/08	SC	ECN 08-021
G	10/05/15	JPD	ECN 15-198

TABLE OF CONTENTS

1	GENERAL INFORMATION	1
2	WARNINGS	1
3	SYSTEM DESCRIPTION	2
3.1	DESCRIPTION OF THE SYSTEM COMPONENTS	3
4	FREQUENTLY ASKED QUESTIONS:	5
5	ANGLE THEORY	6
6	LENGTH THEORY	9
6.1	CABLE REEL LENGTH CABLE REPLACEMENT PROCEDURE	11
6.2	CABLE REEL REPLACEMENT PROCEDURE	12
6.3	CABLE REEL LENGTH SENSOR REPLACEMENT PROCEDURE	12
6.4	LWG CABLE REEL LENGTH/ANGLE SENSOR REPLACEMENT PROCEDURE	13
7	PRESSURE THEORY	15
8	LOAD THEORY	16
9	A2B PROBLEM	16
10	A2B PROBLEM – HARDWIRED A2B OPTION	19
11	CONSOLE DISPLAY	20
12	ANTI-TWO BLOCK SYSTEM SETUP	21
12.1	SETUP OVERVIEW	21
12.2	REGISTERING DEVICES	21
12.3	DELETING DEVICES	24
12.4	SERVICE AND MAINTENANCE	24
13	CAN-BUS COMMUNICATION	26
14	TROUBLESHOOTING A SENSOR PROBLEM USING THE DISPLAY	31
15	DRAWINGS	32
15.1	CONSOLE/CENTRAL UNIT TO CRANE WIRING DIAGRAM	32
15.2	LENGTH/ANGLE SENSOR WIRING DIAGRAM	33
15.3	HARDWIRED A2B WIRING DIAGRAM	34
16	SPARE PART LISTINGS	36
16.1	CONSOLE/CENTRAL UNIT	36
16.2	PRESSURE TRANSDUCER BLOCK	37
16.3	ANGLE SENSOR BOX	38
16.4	CABLE REEL ASSEMBLY	39
16.5	CABLE REEL ASSEMBLY	40
16.6	RADIO A2B	41
17	SERVICE SCREEN FOR SENSOR CALIBRATION	42
17.1	ACTIVATING THE SERVICE SCREEN FOR SENSOR CALIBRATION	42
17.2	ZERO-SETTING THE TRANSDUCER INPUTS	42
17.3	CALIBRATE LENGTH INPUT	43
17.4	CALIBRATE ANGLE INPUT	44
18	ERROR CODES	47

19	TROUBLESHOOTING MOISTURE	53
19.1	WATER INGRESS	53
19.2	CONDENSATION	54

1 GENERAL INFORMATION

This service manual is designed to assist a service or maintenance person in identifying system problem areas or malfunctions. A digital voltmeter with the capability to measure current will be required, along with standard maintenance and service tools. NOTE: Knowledge of how to use a voltmeter to measure both voltage and current is assumed.

REFERENCE:

For system operation, refer to the consoles operator's manual 031-300-190-165.

2 WARNINGS

The LMI is an operational aid that warns a crane operator of approaching overload conditions and of over hoist conditions that could cause damage to equipment and personnel.

The device is not, and shall not, be a substitute for good operator judgment, experience and use of accepted safe crane operating procedures.

The responsibility for the safe crane operation shall remain with the crane operator who shall ensure that all warnings and instructions supplied are fully understood and observed.

Prior to operating the crane, the operator must carefully and thoroughly read and understand the information in this manual to ensure that he knows the operation and limitations of indicator and crane.

Proper functioning depends upon proper daily inspection and observance of the operating instructions set forth in this manual. Refer to Section 6. *Pre-Operation Inspection and Calibration Verification* of this handbook.



The LMI can only work correctly, if all adjustments have been properly set. For correct adjustment, the operator has to answer thoroughly and correctly all questions asked during the setup procedure in accordance with the real rigging state of the crane. To prevent material damage and serious or even fatal accidents, the correct adjustment of the LMI has to be ensured before starting the crane operation.

3 SYSTEM DESCRIPTION

The DS 85 system is a CAN bus system consisting of a central micro processor unit/operating console, length/angle sensor, pressure transducers, and anti-two block switches.

The Load Moment Indicator system operates on the principle of reference/real comparison. The real value, resulting from the pressure measurement is compared with the reference data, stored in the central processor memory and evaluated in the micro processor. When limits are reached, an overload warning signal is generated at the operator's console. At the same time, the aggravating crane movements, such as hoist up, telescope out and boom down, will be stopped.

The fixed data regarding the crane, such as capacity charts, boom weights, centers of gravity and dimensions are stored in memory in the central processor unit. This data is the reference information used to calculate the operating conditions.

The operating modes are selected by the operating mode key on the console by scrolling through the text messages defining the boom truck configuration.

The crane load is measured by pressure transducers attached to the piston and rod side of the hoist cylinders.

Boom length and boom angle are transmitted by length/angle CAN bus node mounted on the side of the boom in the angle sensor box. The length sensor/cable reel is mounted inside the base which measures the boom length.

The PAT RATB works like our normal Anti-Two-Block. It alerts to an impending two-block condition. This alert can come in the form of an audible alarm and visual LED or with the optional function lockout if the crane is so equipped.

The iSENS HES-W1 is a battery operated limit switch for the detection of the hoist limit condition, e.g. on the lifting rope of a crane. The wireless module with integrated battery compartment serves the wireless transmission of the hoist limit condition to suitable wireless receivers. An operating period of up to 2 years is achieved by the use of power-saving techniques when using lithium batteries.

The receiver is mounted into a receiver box located near the operating station. The receiver box provides the following indications: Power, Online, Info, and Low Battery. The receiver will work 10..30VDC and fused to 1 Amp.

3.1 DESCRIPTION OF THE SYSTEM COMPONENTS

Fig. 1: Components of the LMI system PAT DS 85

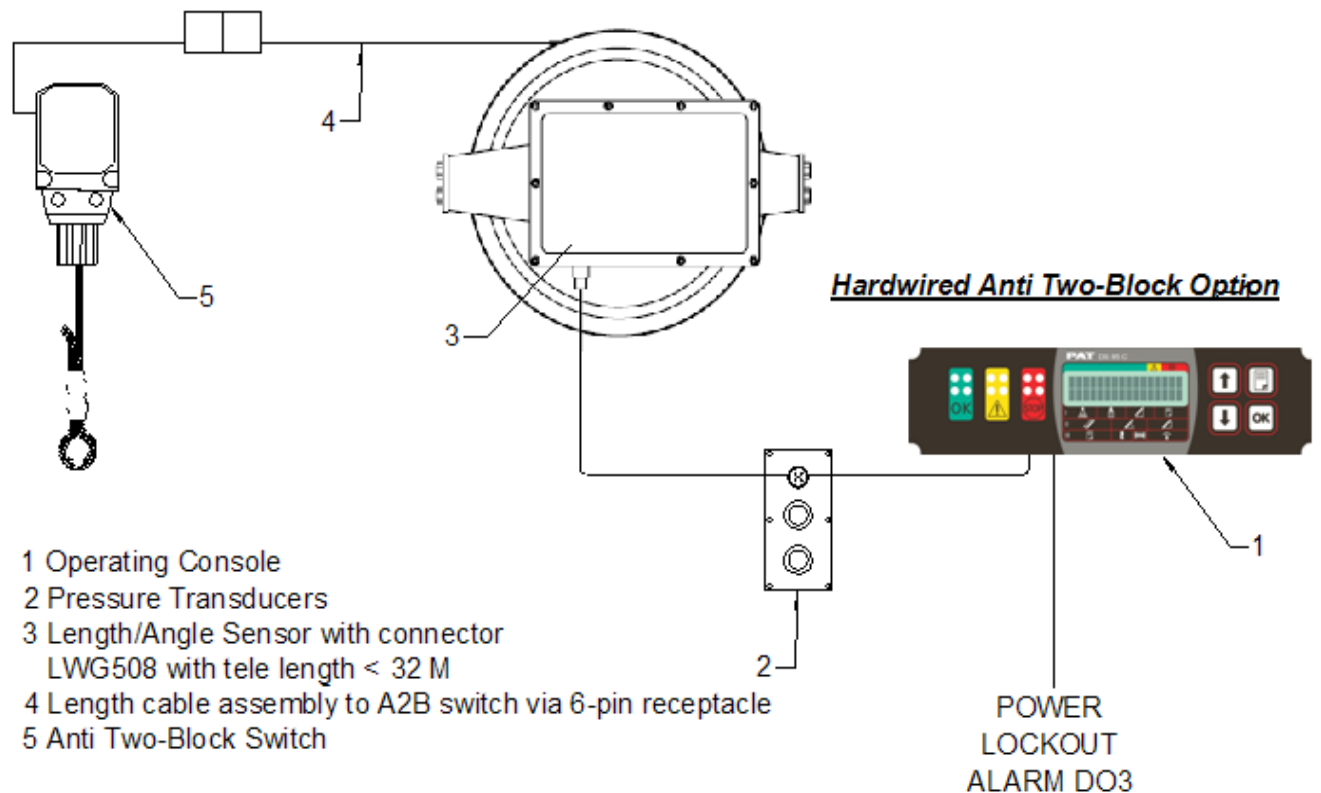
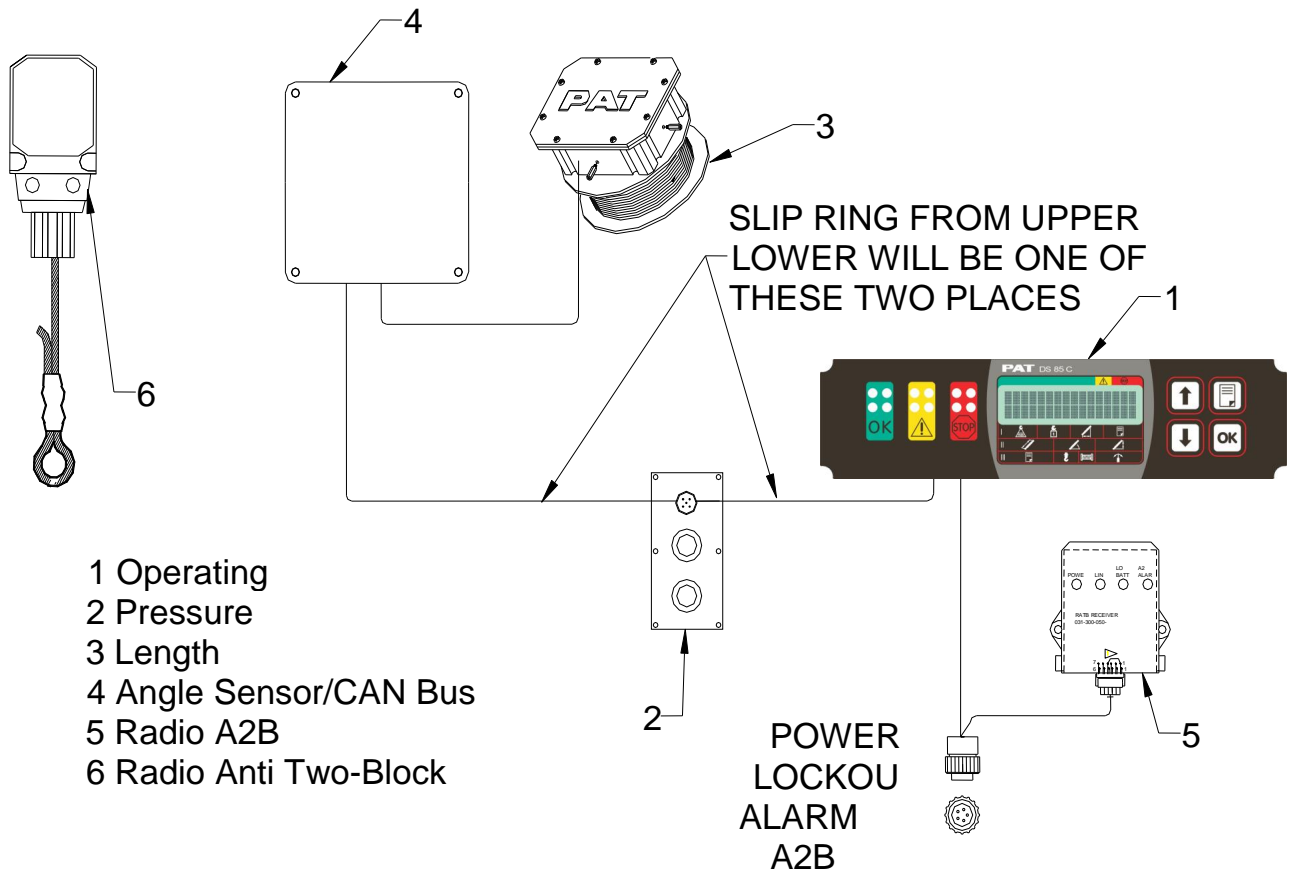

Central Unit/Console: Inside the console there is a CPU and connection board. The board has a hard mounted connector for power, ground, bus controller, and slew indication. Displays all geometrical information such as actual load, maximum load permitted by load chart, working radius, and length, angle, and head height of main boom. It also has LED's for operating condition "OK", overload, and a pre-warning. An output to an alarm horn and a warning light are also available. The display allows for a simple configuration setup, as well as sensor calibration (zero adjustment), and troubleshooting sensor output screen.

Pressure Sensor: The pressure sensor transforms hydraulic pressure into an electric signal. A pressure sensor block houses two sensors, CAN bus controller, and two bus connectors. One pressure sensor is connected to the piston side of the lift cylinder and the other to the rod side.

Length Sensor: A reeling drum drives a potentiometer that measures the length of the boom. This sensor is connected to the CAN bus sensor board in the angle sensor box.

Angle Sensor: The angle sensor is a potentiometer driven by oil damped and weighted pendulum that measures the angle of the boom. This sensor is connected to the CAN bus converter board in the angle sensor box.

Anti-Two-Block Receiver: The anti-two block receiver console has several LED lights for quick status indication including POWER, ONLINE, LOW BATTERY, and INFO. When the weight is lifted on the A2B switch or a signal is not received from the transmitter, the receiver disengages a relay output and drops power from the lock out solenoid valves.

Anti-Two-Block Transmitter and Switch: The anti-two block switch monitors the load block and its relationship with the head of the boom. In working condition the switch is closed. The weight at the anti-two block switch keeps the switch closed until the hook block strikes it. When the hook block strikes the weight, the circuit opens and the transmitter sends a signal to the receiver. The transmitter has an LED on the bottom for diagnostics. The LED should light momentarily when a two-block condition occurs or when the weight is lifted. The LED will then flash rapidly during a two-block condition and will stop flashing after the switch remains in this state for more than 15 seconds. The LED will flash approximately every 2 seconds when the switch is transmitting. When in sleep mode, the LED will not flash.

Hardwired Anti-Two-Block Switch: The anti-two-block switch monitors the load block and it's relationship with the head of the boom. In working condition the switch is closed. When the load block strikes the weight the circuit opens, disengaging a relay output to the lock out solenoid valves, where applicable. To check the cable for damage, (short circuit to ground) there is a 4.7k resistor between ground and the contact of the switch, to give a signal back to the central unit. The weight at the anti-two-block switch keeps the switch closed until the load block strikes it.

4 FREQUENTLY ASKED QUESTIONS:

So, what's wrong? Assuming you are reading these pages because of some kind of problem with the PAT system, let us try to guide you quickly to solving the problem. In most cases, your problem will fall under the following categories:

- I HAVE AN ERROR CODE INDICATED ON THE CONSOLE

Please go to section [Error Codes!](#)

- THE DISPLAYED ANGLE DOES NOT MATCH THE ACTUAL BOOM ANGLE

Start in section [Angle Sensing](#) to check the indicated angle.

- THE DISPLAYED LENGTH DOES NOT MATCH THE ACTUAL BOOM LENGTH

Start in section [Length Sensing](#) to check the indicated length.

- THE DISPLAYED LOAD DOES NOT MATCH THE ACTUAL LOAD

Please note that the indicated load is calculated by the system from the geometry information in the computer, the operator's selections, and all the sensor inputs. If the load display is off, it can therefore be due to an error in any or several of these inputs! Refer to section [Load sensing](#) to narrow down the source of your problem.

- THE CONSOLE DISPLAY IS BLANK

If the console does not show any sign at all (no lights, no buzzer, no display), the problem is either in the wiring between console and crane power, or the console itself. Refer to section [No console display](#) for further troubleshooting.

- I HAVE AN A2B PROBLEM

Please go to section [A2B PROBLEM](#)

- I HAVE A CAN-BUS PROBLEM

Please go to section [CAN-Bus Communication](#)

- I NEED TO IDENTIFY A SPARE PART

Please go to the [Spare Part Listings](#)

- I HAVE NOTICED WATER IN SOME PART OF THE SYSTEM

Please go to section [Troubleshooting Moisture](#)

5 ANGLE THEORY

The System measures the angle of the main boom of the machine with an angle sensor. The angle sensor is contained within the angle sensor box (*Radio A2B option*) or within the Cable Reel (*Hardwired A2B option*) located on the left side of the main boom.

Block Diagram

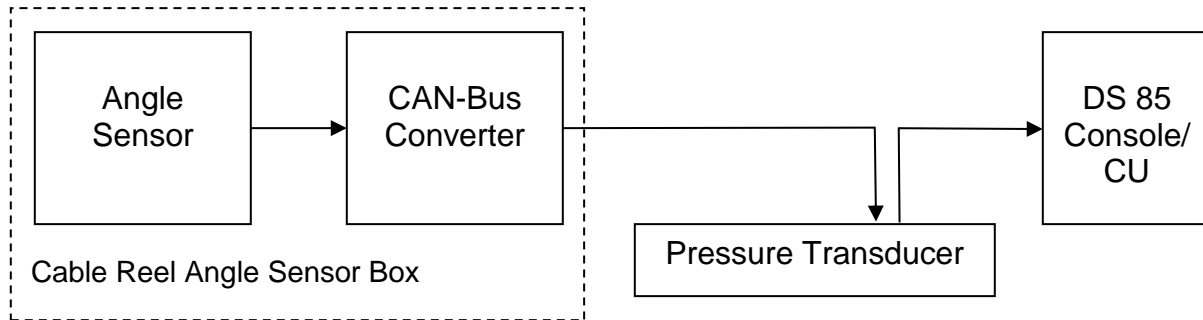

The signal runs from the angle sensor to the Can-Bus converter board, both located in the angle sensor box. From there, it travels as digital information on the CAN-Bus to the pressure sensor, which acts as a T-connector to the main CAN-Bus running to the console/central unit.

So, what do you do when you are having a problem with your angle read-out?

Start by verifying the angle display. Refer to the section "[Troubleshooting A Sensor Problem Using The Display](#)" to call up the sensor signal on your console display. The CAN-Bus is digital and as such will either transmit the signal correctly or not at all. If your readings are off, you have to determine what is causing the problem. Start by opening the angle sensor box and locate the angle sensor (top) and the CAN-Bus converter board (bottom):

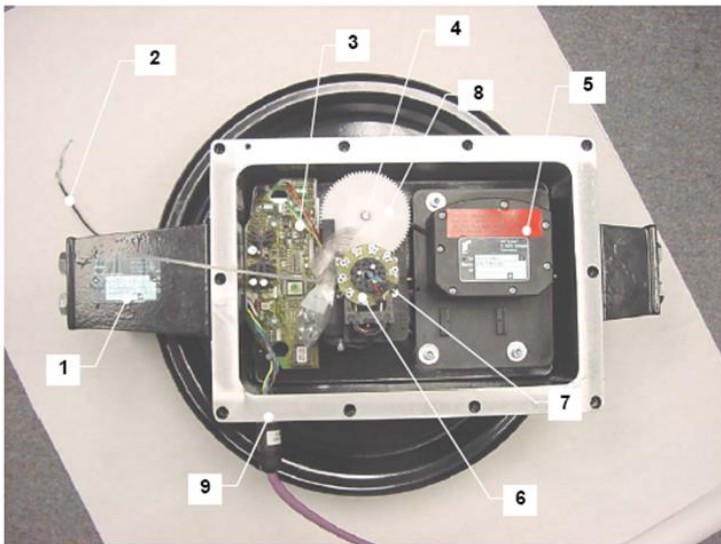

CAN-Bus electronics in cable reel.



CAN-Bus electronics in angle sensor box.

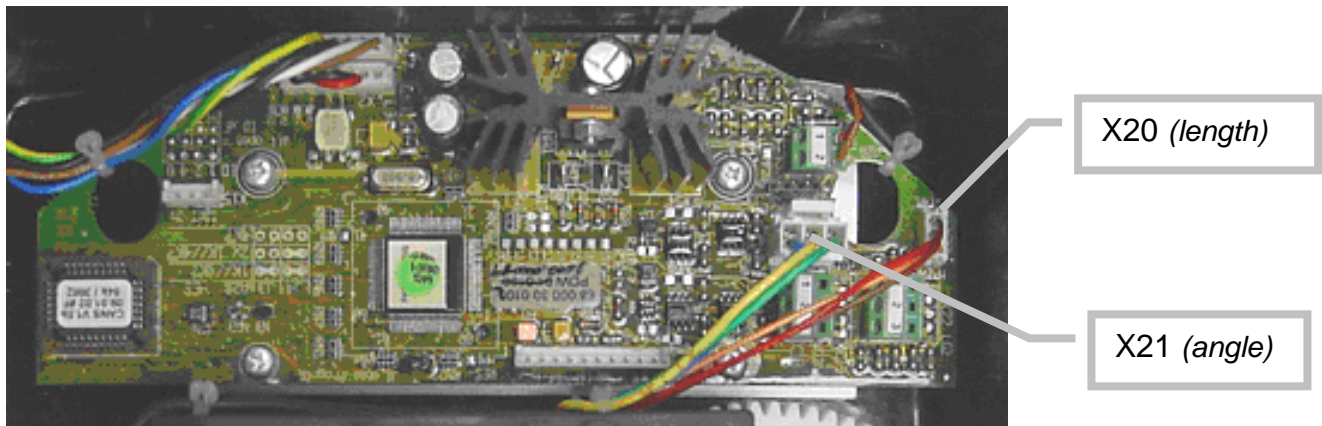

CAN-Bus electronics in angle sensor box.

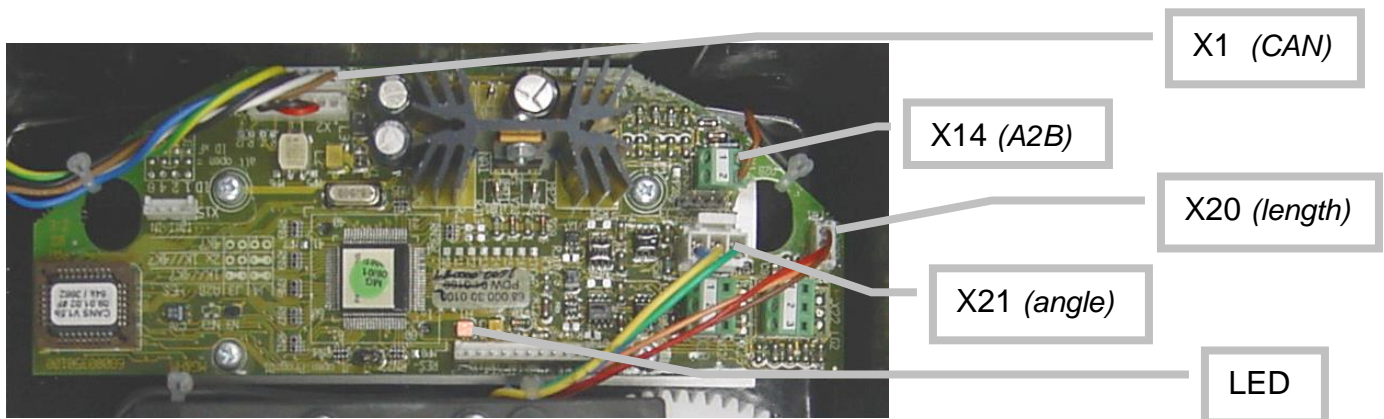

CAN-Bus electronics in cable reel.

The angle sensor has a potentiometer built in that is driven by a pendulum. As the angle changes, so will the pendulum and with it the potentiometer's axle. The converter board supplies a constant voltage of 5V to the angle sensor and in return monitors the voltage of the potentiometer. The terminal used is X21. The angle sensor is connected as follows:

Terminal X21	
1	+ 5V
3	Signal
5	GND

Verify that the sensor is being supplied with 5V by measuring between pin 5 (GND) and Pin 1 (+) of terminal X21. If the voltage is outside of a range of 4.75 to 5.25V, the converter board might be defective. Unplug angle sensor and measure again. If the voltage is still off, exchange converter board. If unplugging the angle sensor made the voltage return into the acceptable range, exchange angle sensor. If the voltage is correct continue:

The angle sensor returns a voltage between 1.875V at 90 degrees and 3.125V at 0 degrees:

Angle Sensor Signal on Pin 3	
Angle	Voltage
90	1.875
75	2.083
60	2.292
45	2.500
30	2.708
15	2.917
0	3.125

Note: Actual voltages will vary slightly.

Measure this voltage between Pin 5 (GND) and Pin 3 of Terminal X21.

If you need to determine the angle for voltages other than the above, do so by using the following formula:

$$\text{Angle (degrees)} = 90 \text{ degrees} - ((\text{Voltage} - 1.875) * 72)$$

If this angle matches your actual angle, but the indicated angle varies significantly (more than 0.4 degrees), the angle sensor is fine and the error is somewhere else. If this angle varies significantly from your actual angle, the angle sensor is bad and needs to be exchanged. Otherwise, continue:

At this point, you have verified that the angle sensor is giving you the right output to match your actual angle, but the system is displaying the wrong angle. If you can rule out software and operator error, it is most likely that the converter board is defective and it needs to be exchanged.

6 LENGTH THEORY

The system measures the length of the main boom of the machine with a length sensor. The length sensor is contained within the cable reel, located in the base of the main boom.

Block Diagram

Radio A2B Option:

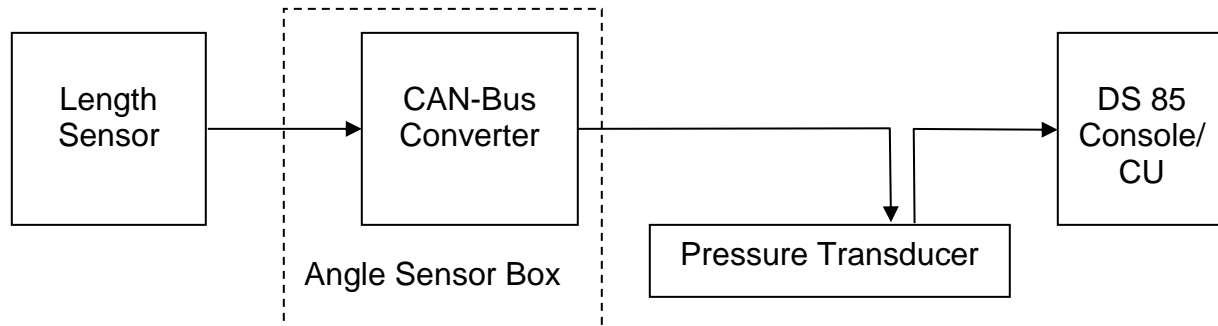

Hardwired A2B Option:

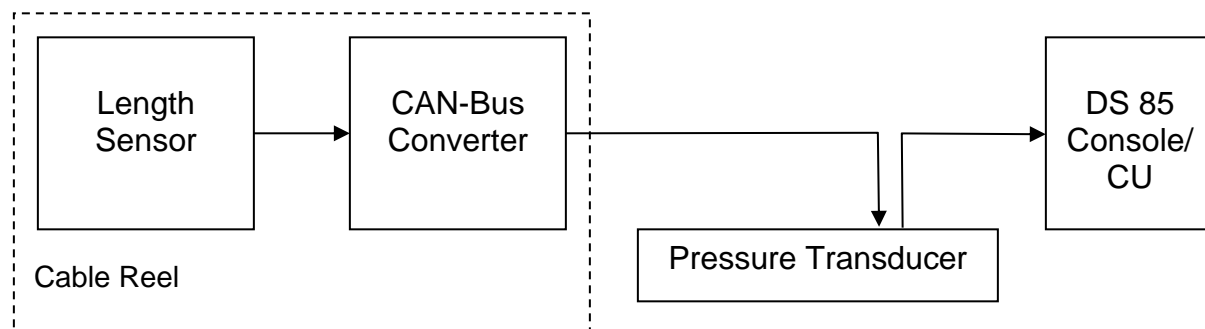

The signal runs from the length sensor to the CAN-Bus converter board, located in the angle sensor box. From there, it travels as digital information on the CAN-Bus to the pressure transducer, which acts as a T-connector to the main CAN-Bus running to the central unit.

So, what do you do when you are having a problem with your length read-out?

Start by verifying the length display. Refer to the section "[Troubleshooting A Sensor Problem Using The Display](#)" to call up the sensor signal on your console display. The CAN-Bus is digital and as such will either transmit the signal correctly or not at all. If your readings are off, you have to determine what is causing the problem. Start by checking the length cable tension, the cable reel has 3-5 turns of pre-loading on the reel.

Go back to your indication screen and compare indicated and actual length again. If the indicated length varies significantly from your actual length (more than 0.3 feet), the length sensor might be bad and needs to be exchanged. Note, however, that the error could be in the converter board.

The length sensor has a potentiometer built in that is driven by a gear drive from the cable drum. As the length changes, the cable drum will turn and with it the potentiometer's axle. The converter board supplies a voltage of about 4.7V to the length potentiometer and in return monitors the output voltage of the potentiometer. The terminal used is X20. The length sensor is connected as follows:

Terminal X20	
1	+ (~ 4.8V)
3	Signal
5	- (~ 0.2V)

Verify that the sensor is being supplied with about 4.7V by measuring between pin 5 (-) and Pin 1 (+) of terminal X20. If the voltage is outside of a range of 4.5 to 5 V, the converter board might be defective. Unplug length sensor and measure again. If the voltage is still off, exchange converter board. If unplugging the length sensor made the voltage return into the acceptable range, exchange length sensor. If the voltage is correct continue:

The length sensor returns a voltage between 0.16V at 0 turns of the length pot (= fully retracted) and 4.84V at 10 turns. How many turns you get at full extension depends on the gear ratio, the boom length, the length cable used and the spooling pattern, so we cannot provide a standard table for it.

What we can give you for trouble-shooting, however is the following table that shows the expected output voltage (measured between X20-5 and X20-3 Signal) for each complete turn of the length potentiometer. Note that this does not sync to the number of turns of the cable reel, though:

Length Sensor Signal on Pin 3		
Potentiometer Turns	Voltage X20-5 to X20-3	Voltage GND to X20-3
0	0.00	0.16
1	0.46	0.62
2	0.93	1.09
3	1.40	1.56
4	1.87	2.03
5	2.34	2.50
6	2.81	2.97
7	3.28	3.44
8	3.75	3.91
9	4.22	4.38
10	4.68	4.84

Note: Actual voltages will vary slightly.

6.1 CABLE REEL LENGTH CABLE REPLACEMENT PROCEDURE

Replace length cable using the following procedure:
Refer to system electrical wiring diagram and cable reel - parts list

1. Remove cable reel and guide from mounting brackets.
2. Remove old length cable from cable drum and machine.
3. Remove cover from cable reel.
4. Disconnect the 4 conductor cable from terminal strip
5. Remove strain relief outer nut and slide cable out of strain relief.
6. Replace length cable.

- Loosen 7mm standoff nut holding pot bracket
- Slide bracket and pot away from worm gear.

NOTE: The cable should roll over the 7/8 inch guide when the cable is extended.

- Replace and feed the cable through the cable guides.
- Install the cable thimble and clamp at the end of the cable.
- Remove the slack in the cable, so the clamp is 1 to 2 inches from the roller guides.
- Pretension the cable reel with 4 full turns on the drum.
- Check the spooling. If spooling is not layered properly, carefully pull the cable out and respool cable.
- Zero pot by turning it counterclockwise until it stops.
- Slide pot and bracket so gears mesh
- Tighten 7mm nut
- Pull cable and inspect gears for binding or slippage.
- Replace 4 conductor cable and connect to terminal strip. Refer to Drawing 1 in Appendix.
- Replace cover.

7. Install cable reel into mounting brackets.
8. Run cable through U-shaped guide in boom, if applicable.
9. Connect thimble to stud in boom.
10. Check length measured and displayed.

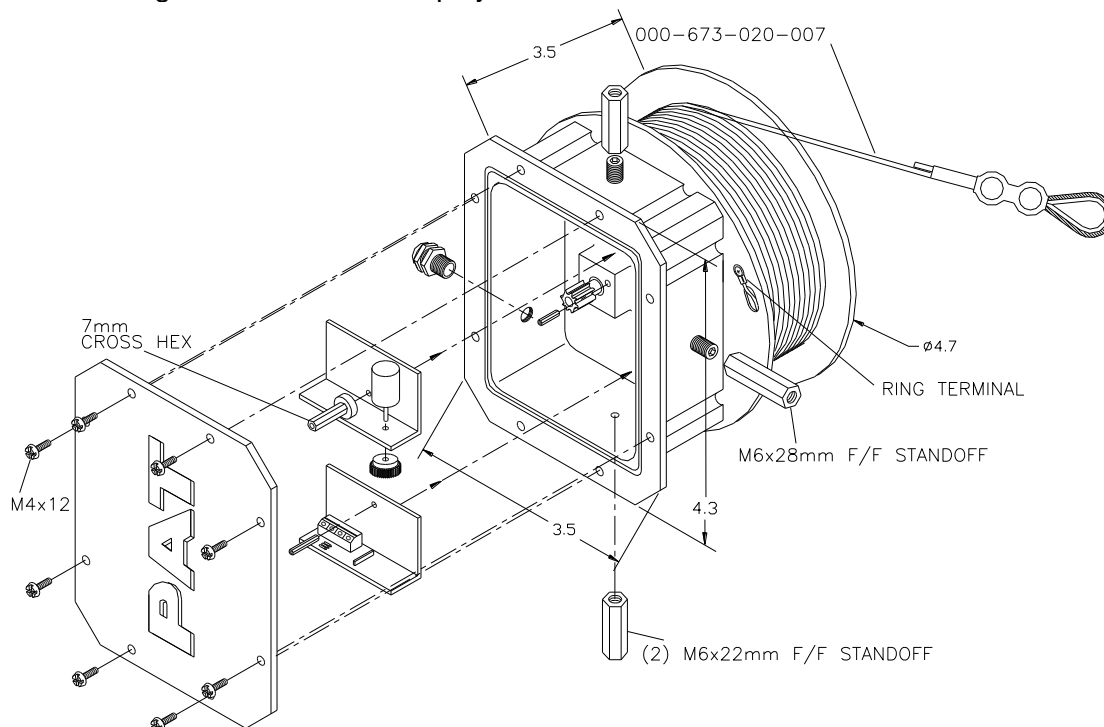

6.2 CABLE REEL REPLACEMENT PROCEDURE

Replace cable reel using the following procedure:

Refer to system electrical wiring diagram and cable reel - parts list

1. Remove cable reel and guide from mounting brackets.
2. Remove cover from cable reel.
3. Disconnect the 4 conductor cable from terminal strip
4. Remove strain relief outer nut and slide cable out of strain relief.
5. Install new cable reel preset from factory.
 - Loosen 7mm standoff nut holding pot bracket
 - Slide bracket and pot away from worm gear.

NOTE: The cable should roll over the 7/8 inch guide when the cable is extended.

- Install the cable thimble and clamp at the end of the cable.
 - Pretension the cable reel with 4 full turns on the drum.
 - Check the spooling. If spooling is not layered properly, carefully pull the cable out and respool cable.
 - Zero pot by turning it counterclockwise until it stops.
 - Slide pot and bracket so gears mesh
 - Tighten 7mm nut
 - Pull cable and inspect gears for binding or slippage.
 - Replace 4 conductor cable and connect to terminal strip. Refer to Drawing 1 in Appendix.
 - Replace cover.
6. Install cable reel into mounting brackets.
 7. Run cable through U-shaped guide in boom, if applicable.
 8. Connect thimble to stud in boom.
 9. Check length measured and displayed.

6.3 CABLE REEL LENGTH SENSOR REPLACEMENT PROCEDURE

Replace length sensor using the following procedure:

Refer to system electrical wiring diagram and cable reel - parts list

1. Remove cable reel and guide from mounting brackets.
2. Remove cover from cable reel.
3. Disconnect the 4 conductor cable from terminal strip
4. Remove strain relief outer nut and slide cable out of strain relief.
5. Replace potentiometer
 - Loosen 7mm standoff nut holding pot bracket
 - Slide bracket and pot away from worm gear.

NOTE: The cable should roll over the 7/8 inch guide when the cable is extended.

- Replace potentiometer.
 - Zero pot by turning it counterclockwise until it stops.
 - Slide pot and bracket so gears mesh
 - Tighten 7mm nut
 - Pull cable and inspect gears for binding or slippage.
 - Replace 4 conductor cable and connect to terminal strip. Refer to Drawing 1 in Appendix.
 - Replace cover.
6. Install cable reel into mounting brackets.
 7. Run cable through U-shaped guide in boom, if applicable.
 8. Connect thimble to stud in boom.
 9. Check length measured and displayed.

6.4 LWG CABLE REEL LENGTH/ANGLE SENSOR REPLACEMENT PROCEDURE

MOUNTING

Mount cable reel on cab side of boom to ensure adequate visibility. Length cable should spool from the top of the drum.

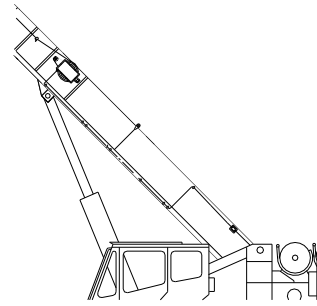

NOTE:

Boom with a flat side: Use four (4) 2-inch hook bolts.

Trapezoidal Boom with a slanted side: Use two (2) 2-inch and two (2) 4-inch hook bolts.

There are four (4) 1/2" holes on the mounting plate.

1. Thread a nut onto the upper threaded part of the hook bolt, then place a lock washer and washer onto hook bolt. Slide bushing on to free end (curved part) of hook bolt.
2. Insert the hook bolt into the holes in the cable reel mounting plate. NOTE: For a trapezoidal boom, the 4" hook bolts go into the top two (2) holes of the mounting plate.
3. Thread a nut onto the threaded part of the hook bolt, then place a lock washer and washer onto bolt to fasten it into place. Repeat for each hook bolt.

NOTE: ALL WELDS MUST BE APPROVED BY THE CRANE MANUFACTURER.

4. Hold plate and hook bolt up to boom and affix to boom, by placing the inside curve of the hook bolts facing outward. Mount cable reel to holes. Front of cable reel should be 1/8" closer to boom than rear. (Front = 2-7/8"; Rear = 3")
5. Adjust nuts up and down to tighten, and to mount the cable reel.
6. Plate should be parallel with boom.

INSTALLATION

1. Set pretension of the cable reel by turning the drum counter-clockwise 5 to 8 turns.
2. Run the length cable through the cable guides and wrap the length cable around the boom tip anchor pin (4 or 5 wraps) and secure with tie wraps. Leave enough length cable to connect to boom tip junction box.
3. Check the spooling. If spooling is not layered properly, carefully pull the cable out and respool the length cable.

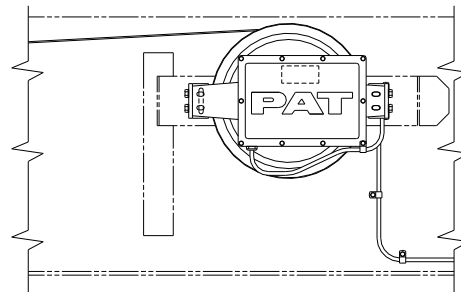

CALIBRATION

1. After installation, remove cover from cable reel. With the boom full retracted and boom stops disengaged (if applicable), adjust the length potentiometer by turning the screw in the center of the large nylon gear on the length sensor counter-clockwise until a soft stop occurs, and reinstall the cover on the reel.

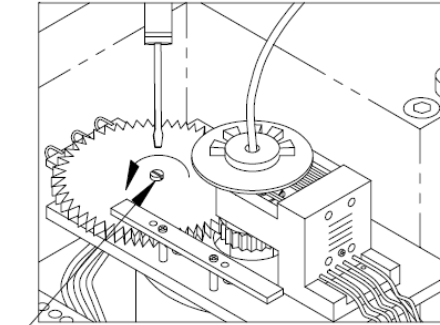

— ADJUST LENGTH POTENTIOMETER, WITH BOOM FULLY RETRACTED
TURN THE CENTER SCREW COUNTER CLOCKWISE TO A SOFT STOP.

The length should be calibrated to be about 0.1 feet (or 0.05m) accurate for both retracted and extended lengths.

2. The angle sensor must be level. Remove cover from reel. Adjust the level of the angle sensor by loosening the socket head cap screws and aligning the top of the angle sensor until parallel with the boom. Reinstall the cover on the reel.

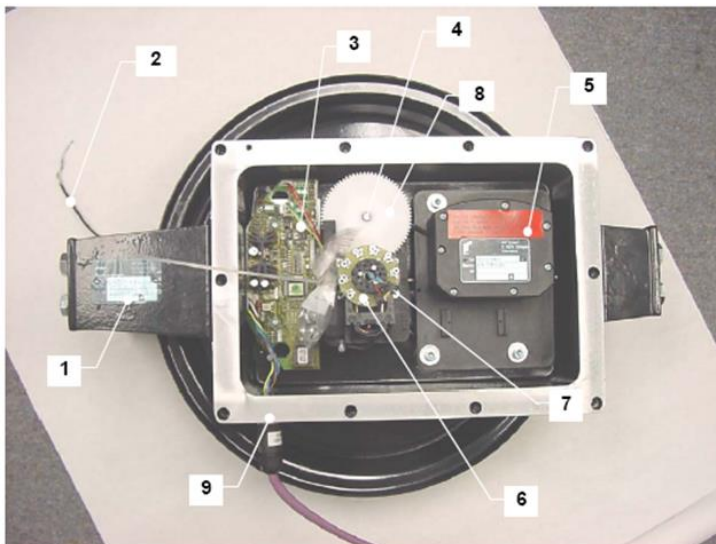
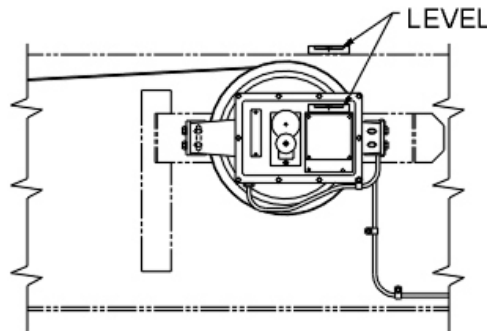

7 PRESSURE THEORY

The System measures the pressure of the boom lift cylinder for both rod- and piston-side. Both sensors are contained within one box that also contains the electronics needed for amplification and creation of the CAN-Bus signal.

Block Diagram:

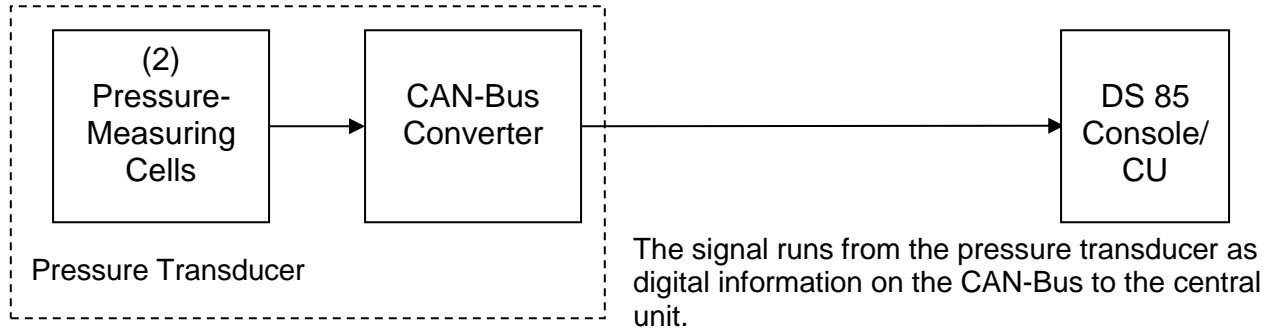

So, what do you do when you are having a problem with your length read-out?

Start by checking the pressure display. Refer to the section "[Troubleshooting A Sensor Problem Using The Display](#)" to call up the sensor signal on your console display.

The easiest spot to check the signal at is when there is no pressure applied to the sensor at all. The only time this is for certain is when your pressure lines are drained and disconnected. In that case, the readout should show about 500mV (+/- 25mV) and 0 PSI. Small variations could be adjusted; see section [Service Screen For Sensor Calibration](#).

The CAN-Bus is digital and as such will either transmit the signal correctly or not at all. If your readings are off, chances are the pressure transducer is defective. Replace.

Note: After exchanging the pressure transducer block, BOTH transducer channels need to be zeroed, see procedure [Zero-Setting The Transducer Inputs](#).

8 LOAD THEORY

Please note that the load displayed by the LMI is not a direct measurement, but a calculated value that is based on a lot of factors. Outside of the measured values (sensors), those include:

- Operator settings such as:
 - Operating mode/configuration
 - Parts of Line/Reeving
- Rigging parts such as:
- Hook block weight
- Sling weights, etc.
- Tip height (length of load line used)
- Boom weights

Before checking the system for a load reading problem, make sure all of the above has been ruled out. When you still feel, the system is reading a sensor wrong and thus displaying an incorrect load, use the following:

Use the above sections and the sensor signal display screen to check the following:

- boom length reading
- angle transducer reading
- pressure transducer readings

If all are correct, use the zero setting and calibration screens to zero pressure transducers, calibrate angle and length. If you still have a problem, replace pressure transducer block.

9 A2B PROBLEM

- CHECK FOR ANTI-TWO BLOCK CONDITION

Are the control levers locked out and is the crane in an anti-two block condition?

YES, Lower the hook block and/or headache ball to correct the two-block condition. If two (2) hoists are in use, both hooks must be lowered.

- CHECK THE LED'S ON THE RADIO ANTI-TWO BLOCK RECEIVER BOX







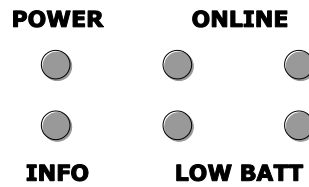



1. 'POWER' (Red)	This Red LED lights to indicate power to the system.
2. 'ONLINE' (Green)	Indicates the status of communication between main hoist A2B transmitter and the receiver. Failure of the communication link will turn off the Green LED and turn off the output to the lockout relay.
3. 'LOW BATT' (Yellow)	Indicates weak batteries specific to channel 1 or 2 when Yellow LED lights.
4. 'INFO' (Red)	Indicates a two-block condition of the main hoist. The Red LED will light when the load-handling device has lifted the A2B weight.



There are 6 LEDs on the front panel of the device, which indicate the status of various operating conditions.



The meaning of the signals can be taken from the table:

	off: 	lights: 	flashes slowly: 	flashes rapidly: 
POWER 	No supply voltage present	Supply voltage is present		
 INFO		Hoist limit switch has triggered <i>or</i> radio link to a hoist limit switch interrupted		
ONLINE  	No sensor registered to this channel	Sensor registered to this channel and ready for operation	During the registration of a new hoist limit switch <i>or</i> sensor in 'sleep' mode	Radio link to the sensor on this channel interrupted
  LOW BATT		Batteries of the sensor on this channel are almost exhausted Replace the batteries soon!		

Which does it mean when the 'Low Batt' LED lights up?

If a '**Low Battery**' LED lights up, this means that the battery set in the respective wireless sensor is exhausted (remaining capacity < 6,5 %) and must be replaced as soon as possible.

What does it mean when the 'Info' LED lights up?

If the '**INFO**' LED lights up, this means that one of the connected wireless hoist limit switches has reported 'hoist limit'. At the same time, the relay contact opens and there is no voltage at the signal output. The LED may also light up briefly after the iFLEX TRS 12 is switched on, until the radio link to the registered hoist limit switches has been established. If the LED remains lit, this means that the radio link to a registered wireless hoist limit switch is interrupted. In this case the 'Online' LED assigned to the respective channel also flashes.

What does it mean when an 'Online' LED flashes rapidly?

If an '**ONLINE**' LED flashes rapidly after conclusion of the self-diagnosis, this means that the radio link to the wireless hoist limit switch on the indicated channel is interrupted. The 'Info' LED also lights up at the same time.

What does it mean when an 'Online' LED flashes slowly?

Slow flashing of an '**ONLINE**' LED in conjunction with the lighting up of the 'INFO' LED means that the wireless hoist limit switch on the indicated channel is in sleep mode. This mode is activated automatically if the hoist limit switch remains in the hoist limit condition for a lengthy period of time. This function serves to reduce the power requirement of the hoist limit switch. The function is reset automatically upon the next switching of the hoist limit switch.

10 A2B PROBLEM – HARDWIRED A2B OPTION

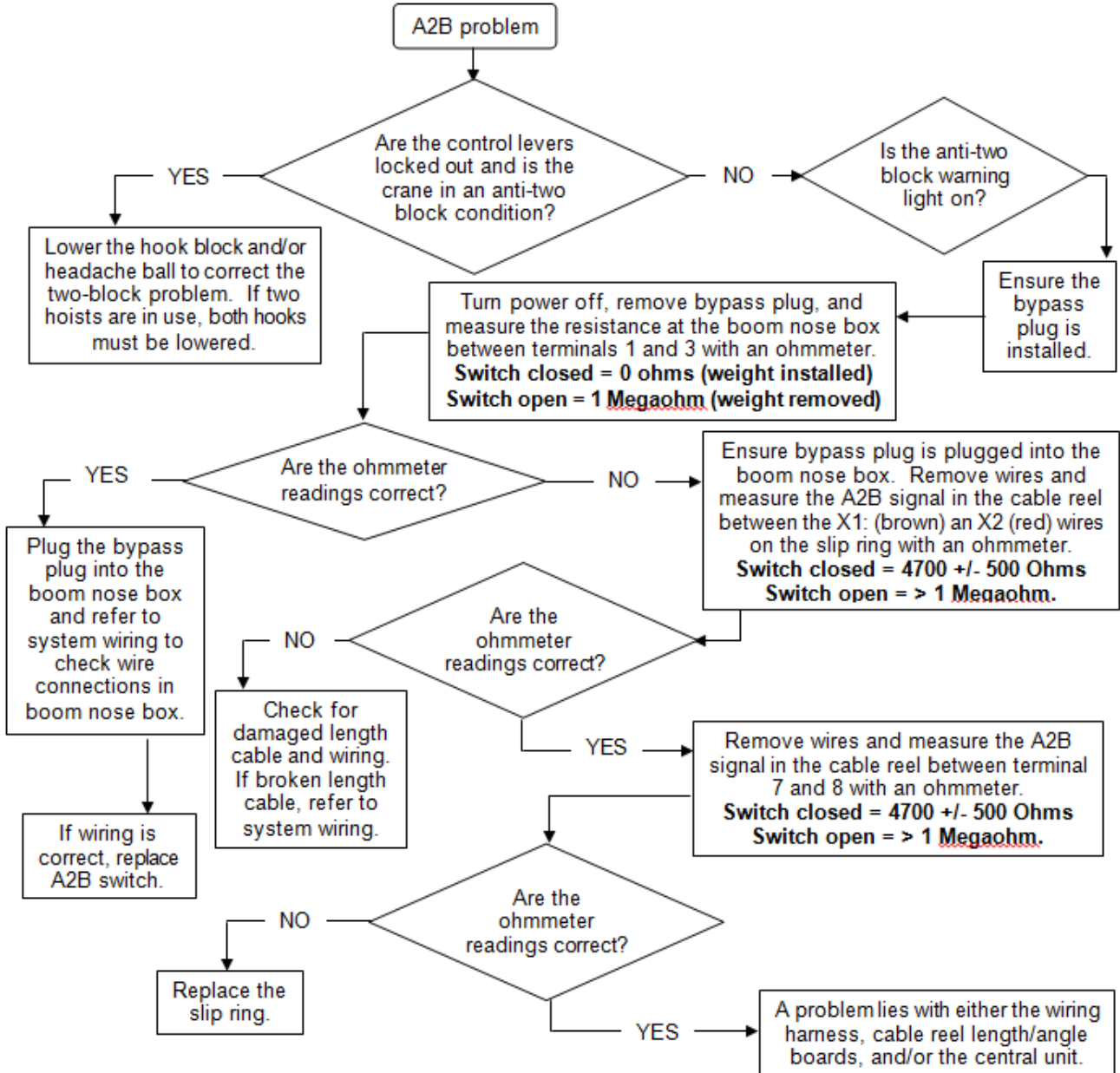

11 CONSOLE DISPLAY

If the console is not showing any lights, such as warning lights, backlighting, etc. it is most likely missing power. Start with the following:



Check if power is being supplied to the console/central unit. Measure on the 16 socket connector. Pin 1 is +Ub (12V), Pin 3 is GND. If you have no power, check wiring harness and crane power. Otherwise, open console:

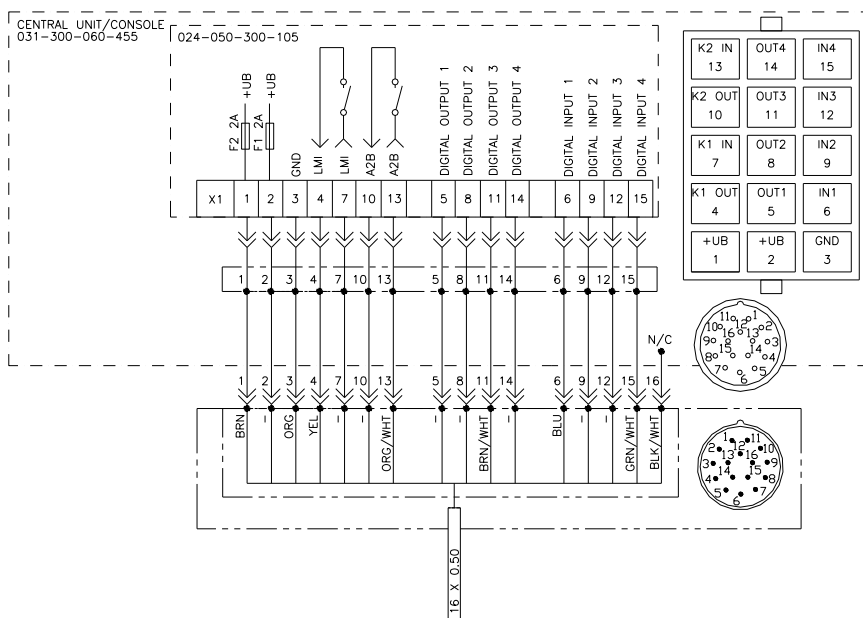

Check fuses in console: F1 and F2 are 2amp fuses located the connection board. Test the F2 fuse by placing an OHM meter across pin 1 of the 16-pin connector and pin 2 of the 5-pin can bus connector. Check for power by using the LED on the underside of the connection board and at Pin 1 = +Ub and Pin 3 = GND. If the LED is on and you have power on the connector, either the software is defective or the console electronics need to be replaced.

Fuses (F1 and F2)

12 ANTI-TWO BLOCK SYSTEM SETUP

12.1 SETUP OVERVIEW

The PAT RATB is easily configured to communicate with up to 2 transmitters. Simply by depressing the red programming button for several seconds, the receiver can sense the transmitters being used and auto-configure to communicate with those transmitters. There are no numbers, ID's, or codes to remember or write down.

Programming
Button

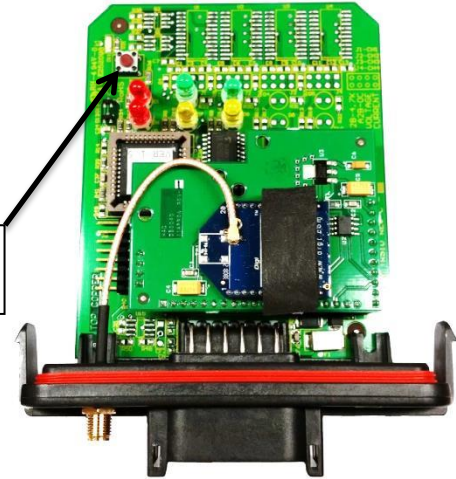

12.2 REGISTERING DEVICES

The programming button is located inside the housing of the device and is only accessible after opening the housing.

- First of all, disconnect the iFLEX TRS 12 from the power supply by pulling out the central plug.
- Follow the procedure described below to open the housing:

HINT

A flat-blade screwdriver with a blade width of 4.5 - 5.5 mm is best suited for opening the housing.

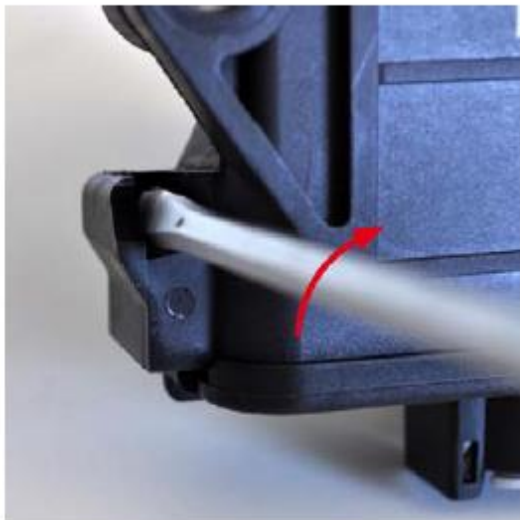

▲ 1. By means of a slight twisting movement of the screwdriver, press the latches (on both sides of the housing at the rear) carefully towards the housing and in this way unlock the circuit board

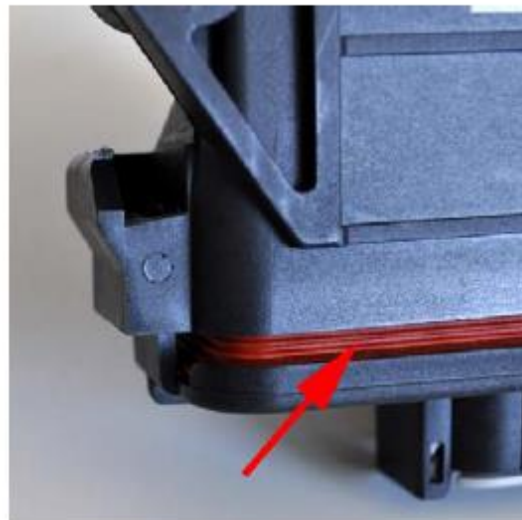

▲ 2. The housing seal will be visible if the circuit board has been unlocked correctly



▲ 3. Carefully pull the circuit board out of the housing



▲ 4. View of the programming button and the LEDs on the circuit board

Follow the procedure described below to register a wireless hoist limit switch.

- The wireless hoist limit switch should be no more than 1 metre away from the iFLEX TRS 12 during the registration phase.
- Connect the iFLEX TRS 12 to the power supply again. (See also Chapter 4.1)

HINT

Keep a fresh set of batteries at the ready for the registration.



▲ 1. First of all, open the battery compartment of the wireless hoist limit switch to be registered by undoing the cover screws and removing the cover of the battery compartment.



▲ 2. Remove the batteries

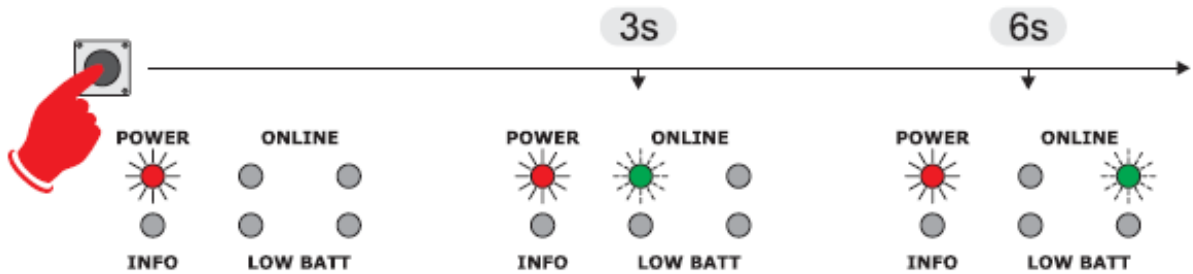

▲ **3.** Press and hold the programming button of the iFLEX TRS12 until:

- Online LED1 flashes (for the registration of a wireless hoist limit switch to channel 1) or
 - Online LED2 flashes (for the registration of a wireless hoist limit switch to channel 2)
- and then release the button.



▲ **4.** Now insert the batteries into the battery compartment of the wireless hoist limit switch to be registered, observing the correct polarity.



▲ **5.** Observe the LED on the underside of the housing. This should light up with short pulses. Now fit the cover of the battery compartment.

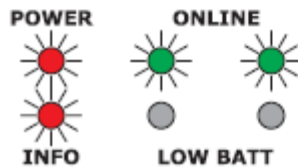

▲ **6.** The wireless hoist limit switch is correctly registered if the respective Online LED 1 and/or LED 2 is lit steadily.

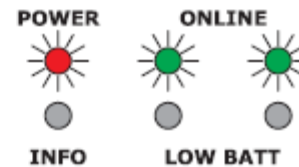

▲ **7.** Now pull on the rope of the wireless hoist limit switch for 5 secs. The system is working perfectly if the 'INFO' LED extinguishes within this time. The wireless hoist limit switch is now ready to be mounted.



▲ 8. Carefully slide the circuit board into the guide rails in the housing. Make sure that the foam strip is positioned as shown.



▲ 9. Lock the circuit board by applying strong pressure to the underside of the housing (clearly audible click at both sides).

12.3 DELETING DEVICES

Wireless hoist limit switches that are being decommissioned must be deleted and deactivated by first removing the batteries.

Follow the procedure described below to delete a wireless hoist limit switch.

1. Open the housing of the iFLEX TRS 12 as described previously.

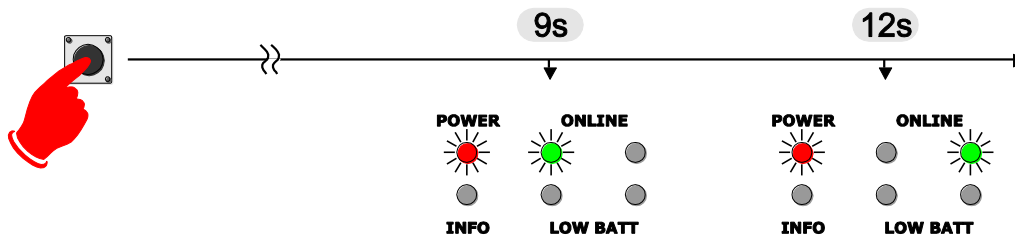

- ▲ 2. Press and hold the **programming button** of the iFLEX TRS12 until:
 - Online LED1 lights steadily (for the deletion of a wireless hoist limit switch from **channel 1**) or
 - Online LED2 lights steadily (for the deletion of a wireless hoist limit switch from **channel 2**) and then release the button.

The wireless hoist limit switch is deleted as soon as the respective 'Online' LED has extinguished.

12.4 SERVICE AND MAINTENANCE

The only maintenance possible is to change the wireless hoist limit switch batteries when required. Also, check the mounting hardware daily to ensure that there is no damage. Replace any damaged parts before operating the crane.

To replace the batteries, remove the four screws from the transmitter housing. During battery replacement, use caution when opening the battery cover and transmitter. Avoid damage to the gasket which could lead to moisture ingress and corrosion of batteries and terminals. Inspect the gasket surface on the transmitter for nicks or other damage that may prevent the gasket from sealing.

Install four fresh batteries into the proper location and direction as indicated on the battery holder. Make sure that the cardboard tube is installed as shown.



Observe the LED on the underside of the housing. This should light up with short pulses. Reinstall the cover of the battery compartment. The wireless hoist limit switch does not need to be registered again following a battery change.

The **iFLEX TRS 12** transceiver does not contain any serviceable parts. The micro-fuse inside the device is self-resetting and therefore does not need to be replaced. If malfunctions occur, power the device off and have it checked. If necessary, schedule repair immediately by an authorized Hirschmann service partner.

Clean the surface of the equipment occasionally with a damp cloth using a mild cleaning agent. However, you should never use abrasive or alcohol-based cleaning agents, as these can damage the housing or the front foil! The device must not be treated with a high pressure cleaner or similarly aggressive methods under any circumstances!

Keep the contact area of the device plug and the antenna connector clean and occasionally check that the connections are tight. If parts are damaged, these must be repaired properly or replaced immediately.

13 CAN-BUS COMMUNICATION

• BRIEF DESCRIPTION OF A CAN BUS SYSTEM

CAN stands for "Controller Area Network". Its intended use is as a serial bus system for a network of controllers. Each controller connected through a CAN chip is called a "node" and is mostly used to acquire data from a sensor. All nodes are connected to a common bus and all nodes are able to simultaneously read the data on that bus. Also, all nodes are able to transmit data on that bus however only one node at a given time has write access to the bus. If the message is relevant, it will be processed; otherwise it is ignored. The unique identifier also determines the priority of the message. The lower the numerical value of the identifier, the higher the priority.

The cable bus is a twisted pair of shielded wire. Data can be transmitted in blocks from 0-8 bytes at a maximum transfer rate of 1 Mbit/s for networks up to 40 meters. For longer network distances the maximum transfer rate must be reduced to 50 Kbit/s for a 1 km network distance. CAN will operate in extremely harsh environments and the extensive error checking mechanisms ensure that any transmission errors are detected.

The system measures the length of the main boom, the angle of the main boom, and the pressures of the lift cylinder via a CAN-Bus connection. Since this is a digital bus connection, it is not possible to measure the signals on the bus with a multimeter. Instead, the LMI provides you with error codes that give you an indication of the bus state.

The error codes are one of the following:

- E61 Error in the CAN bus data transfer for all CAN units
- E62 Error in the can bus data transfer of the pressure transducer sensor unit
- E63 Error in the can bus pressure transducer sensor unit
- E64 Error in the can bus data transfer of the length/angle sensor unit
- E65 Error in the can bus length/angle sensor unit

Block Diagram

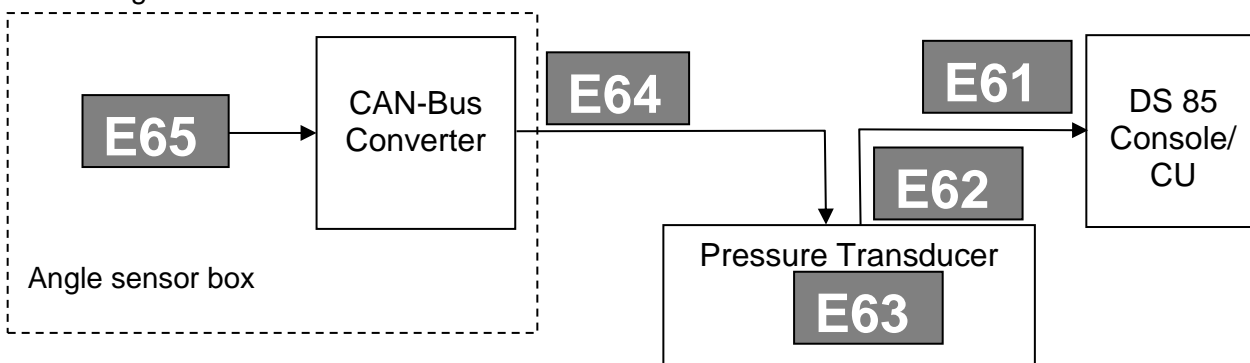

The block diagram tries to clarify that: If the CU does not see any CAN-Bus component, it will report an E61. If it sees only the cable reel, it will report an E62 (pressure transducer missing). If it sees only the pressure transducer, it will report an E64 (cable reel missing). E63 means that the pressure transducer is available, but is reporting an internal error. E65 means that the cable reel unit is available, but is reporting an internal error.

So, what do you do when you are having a problem with one of those codes?

- E61

In case of an E61, start by checking your cabling. You can verify that power is being supplied to the sensor by testing the CAN connectors per this layout:

Connector M12, 5 contacts

Pin Layout (CiA DR-303-1 7.2)

Pin 1 Shield
 Pin 2 + U_b
 Pin 3 Ground
 Pin 4 CAN High
 Pin 5 CAN Low



Measure between pins 3 and 2 for crane voltage. If you see voltage, check all pins for continuity. Remember, the CU is reporting that neither CAN-Bus converter board nor pressure transducers are present.

Finally, check the 2 amp fuses in the console. If a fuse is blown, replacement of the 2 amp fuse is required. This condition can be tested by placing an OHM meter across pin 1 of the 16-pin connector and pin 2 of the 5-pin can bus connector.

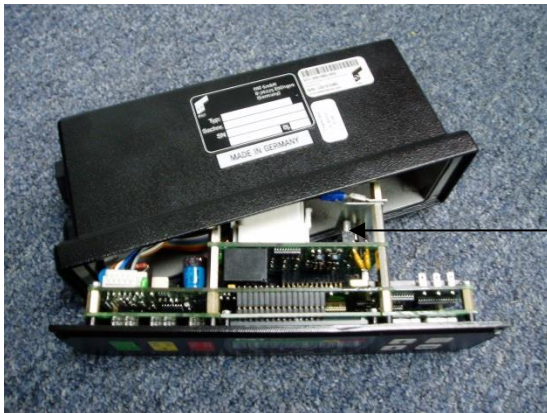
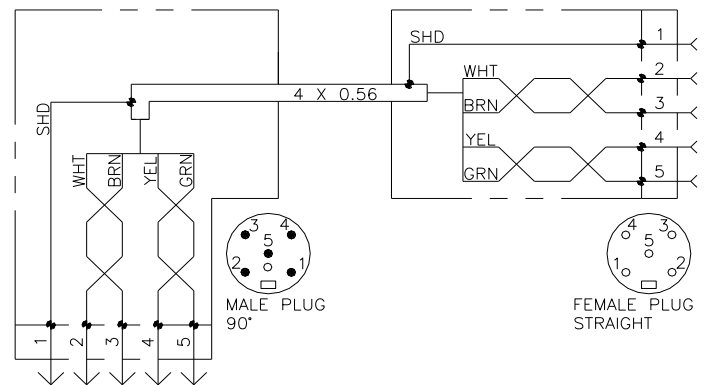

2 amp fuse location

- E62

In case of an E62 the CU is reporting no signal from the pressure transducer. Start by checking your cabling between CU and pressure transducer, even though it is not very likely that there is a problem with it since the same cable carries also the signals from the cable reel and those appear to be fine. You can verify that power is being supplied to the sensor by testing the CAN connectors per the above pin layout. If you are sure that the sensor is being supplied, you have to replace the pressure transducer.

- E63

In case of an E63, the pressure transducer is reporting an internal problem. You cannot troubleshoot any further, but need to replace the pressure transducer.

• E64

In case of an E64, the CU is reporting no signal from the CAN-Bus converter board in the angle sensor box. Start by checking your cabling between pressure transducer and cable reel. You can verify that power is being supplied to the sensor by testing the CAN connectors per the above pin layout or by opening up the angle sensor box (remove the lid) and making sure the red LED on the board is blinking. If not, most likely power is missing.

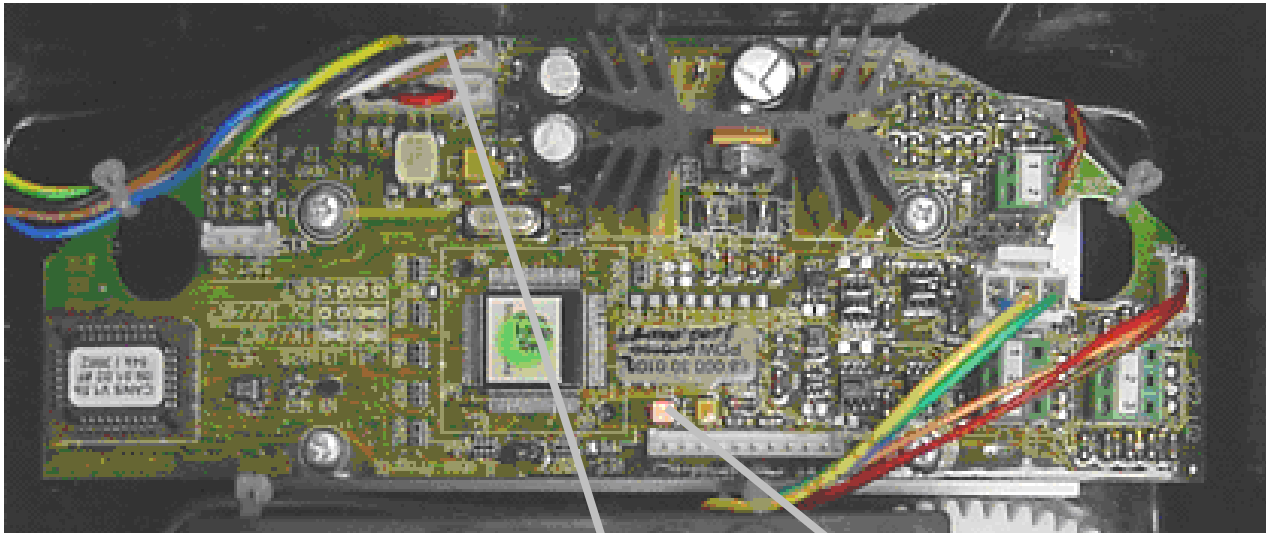

CAN-Bus electronics in length/angle sensor box.

Verify by measurement on connector X1:

X1 Pin	CAN
1	CAN_SHLD
2	CAN +UB
3	CAN GND
4	CAN_H
5	CAN_L

X1 (CAN)

LED

Measure between pins 3 (GND) and 2 (+). Next, check all pins of the CAN bus cable for continuity and cross-check for short circuits. E-64 means that the pressure transducer is working fine, but the cable reel is not – so we most likely have a defective connection between those two components. If this is tested to not be the case (missing connections, short circuits – measure with Ohm-meter), the board in the cable reel might be defective (see also chapter [Angle Sensing](#)).

If you suspect a sensor error or problem with a sensor, compare the indicated physical value of the sensor on the display screen with the real value, i.e. length, angle, etc.

The voltages given are internal calculation values only; you will not be able to actually measure them anywhere on the electronics! Typical values to be expected are:

- Pressure transducers (piston and rod), 500mV @ 0 PSI; 4500mV @ maximum PSI
- Length sensor, 500mV @ retracted boom length; voltage extended depends on the various boom lengths.
- Angle sensor, 4500mV at 0°; 2500mV at 45°; or 500mV at 90°

Please refer to table below for more values.

Voltage Values displayed [mV] +/- 10mV	Value displayed	Value
Pressure Transducers 300 bar, type 314	<i>PSI</i>	<i>Bar</i>
500	0	0
1500	1088	75
2500	2176	150
3500	3263	225
4500	4351	300

Angle Sensor		<i>degrees</i>	
500	90		boom vertical
1500	67.5		
2500	45		
3500	22.5		
4500	0		boom horizontal

Length Sensor		<i>feet</i>	
500	0		fully retracted
1500			
2500			
3500			
4500			

If the displayed value does differ from the actual value, please refer to the following sections to find the cause of the problem:

If the displayed angle is incorrect, please go to section [Angle Sensing](#).

- E65

In case of an E65, the CAN-Bus converter board in the angle sensor box is reporting an internal problem. In most cases, this will be an angle sensor, or length potentiometer. Go to those chapters ([Angle Sensing](#), [Length Sensing](#)) to continue trouble shooting.

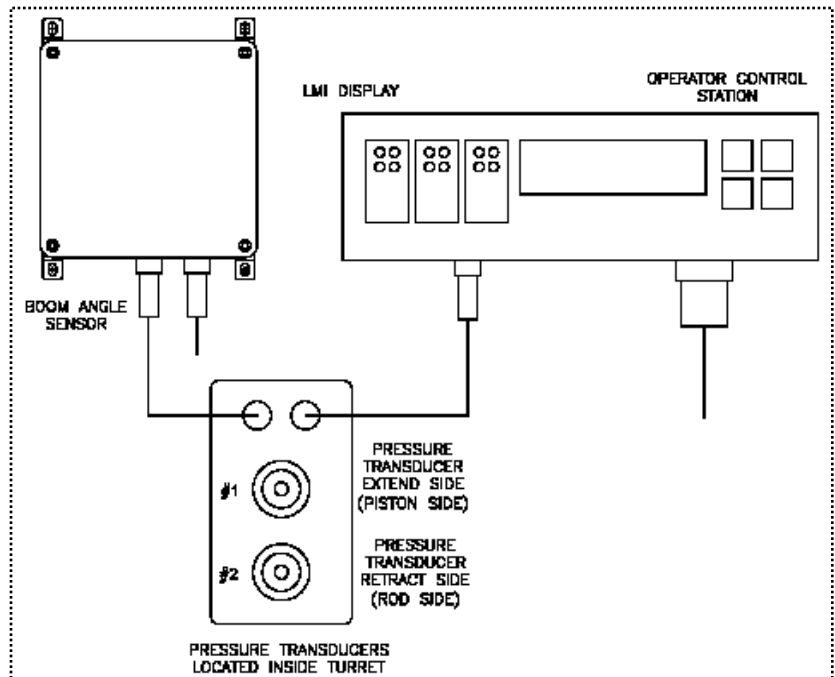
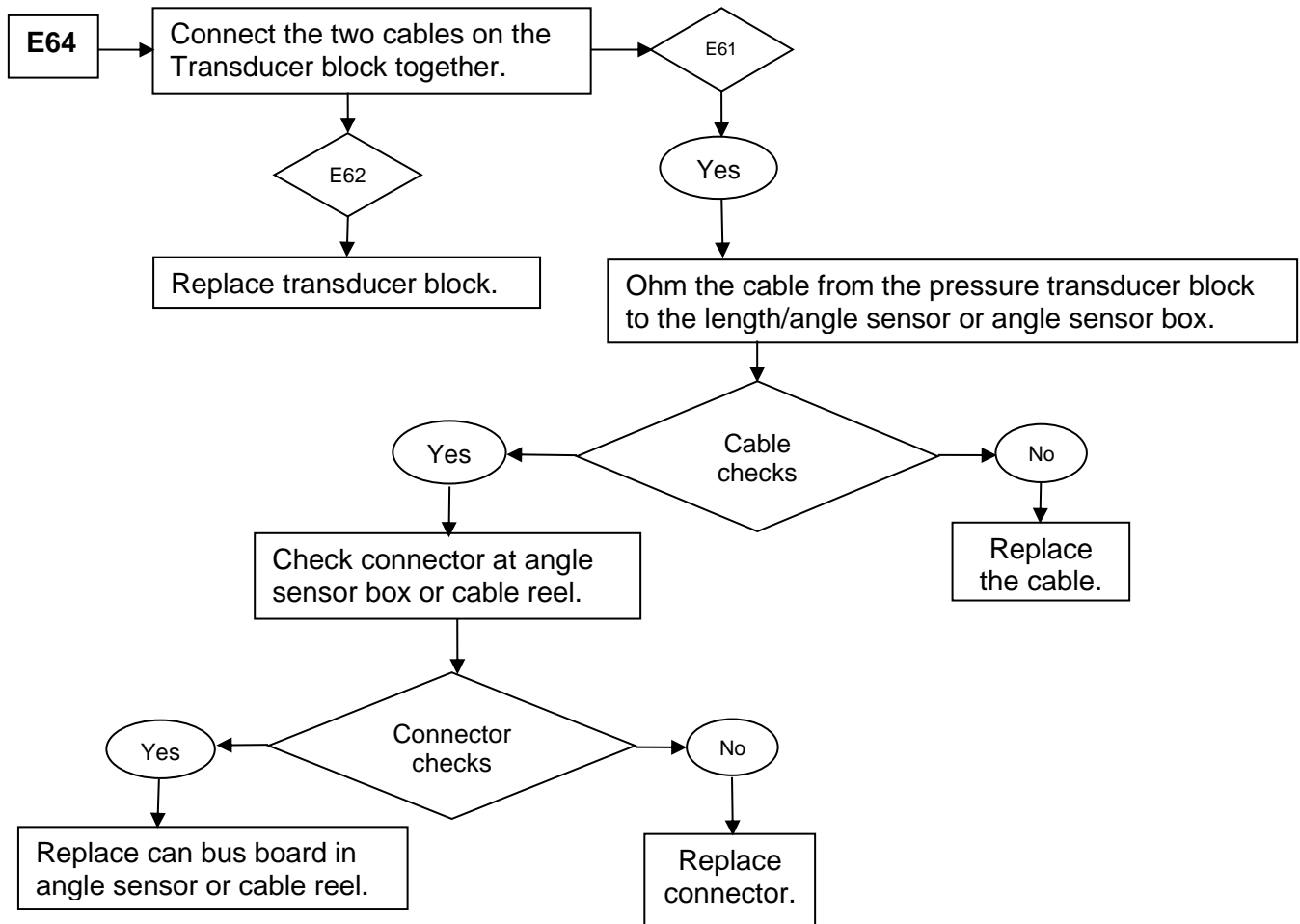



14 TROUBLESHOOTING A SENSOR PROBLEM USING THE DISPLAY

To determine whether there is a problem with a sensor, the system has “sensor output screen” built in to make trouble-shooting easier. This is the right place to start if you are suspecting a problem with a sensor (and you don’t have an error code displayed).

The screen will show all sensor inputs as in the example below. For each sensor, an equivalent voltage is shown in millivolts, along with the physical sensor value that that voltage refers to. Pressure sensors are shown with physical values of [bar], angle sensors in degrees and length sensors in feet (or meter for metric charts).

Enter the service screen using the procedure is described below:

To start function press  + 

 SENSOR OUTPUTS EXIT

press  to select the limit marked at the upper left of the screen.

Scroll through the following screen to see piston and rod side voltages and pressures.

PISTON / ROD

1532mV 0685mV 1131. PS 206. 4 PS

And length and angle voltages and measurements.

LENGTH / ANGLE

0502mV 2025mV 30.6 ft 55.7°

The values shown in the screen here are just examples of actual values. Refer to the table listed below for actual value ranges.

15 DRAWINGS

15.1 CONSOLE/CENTRAL UNIT TO CRANE WIRING DIAGRAM

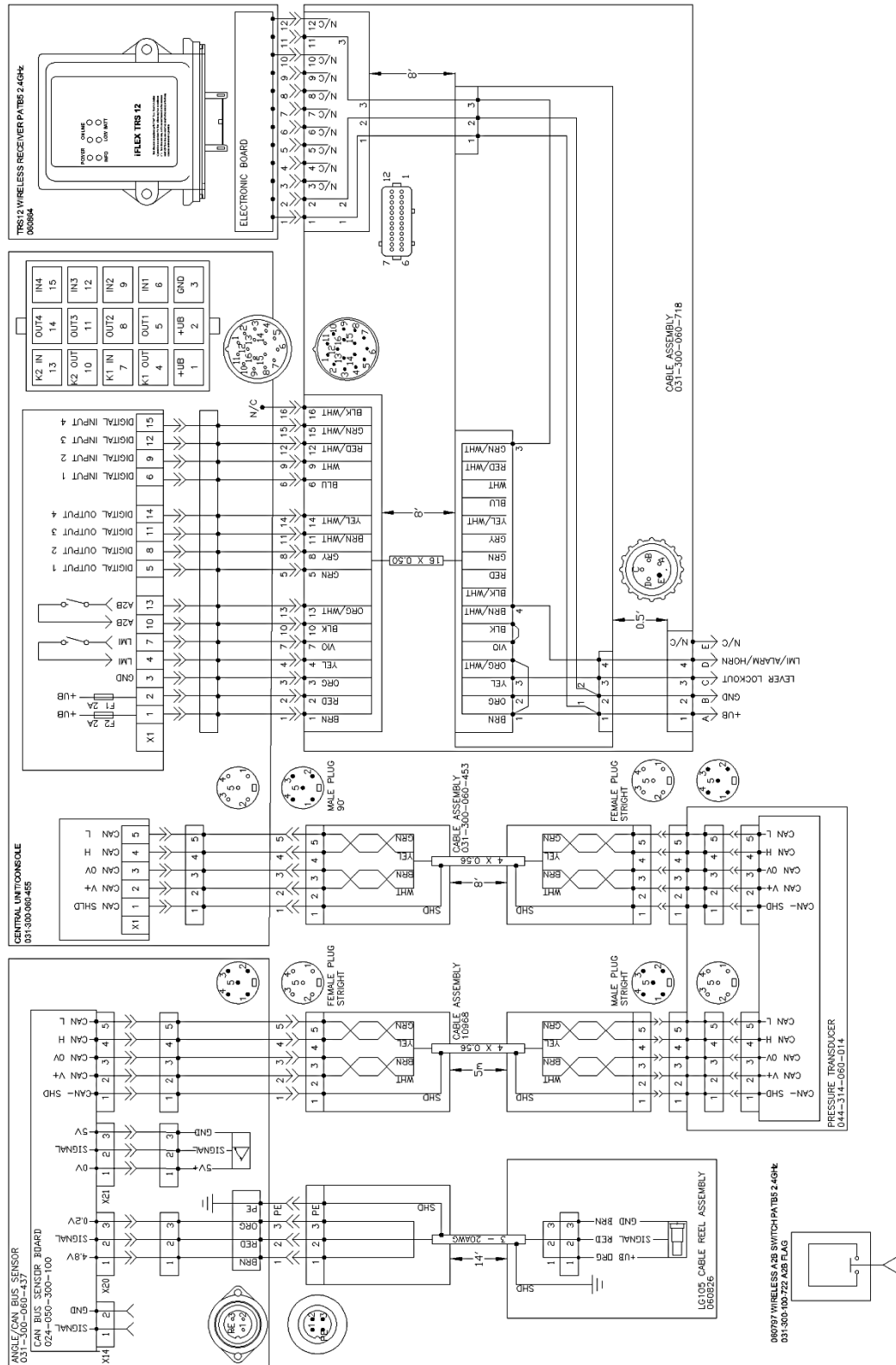

15.2 LENGTH/ANGLE SENSOR WIRING DIAGRAM

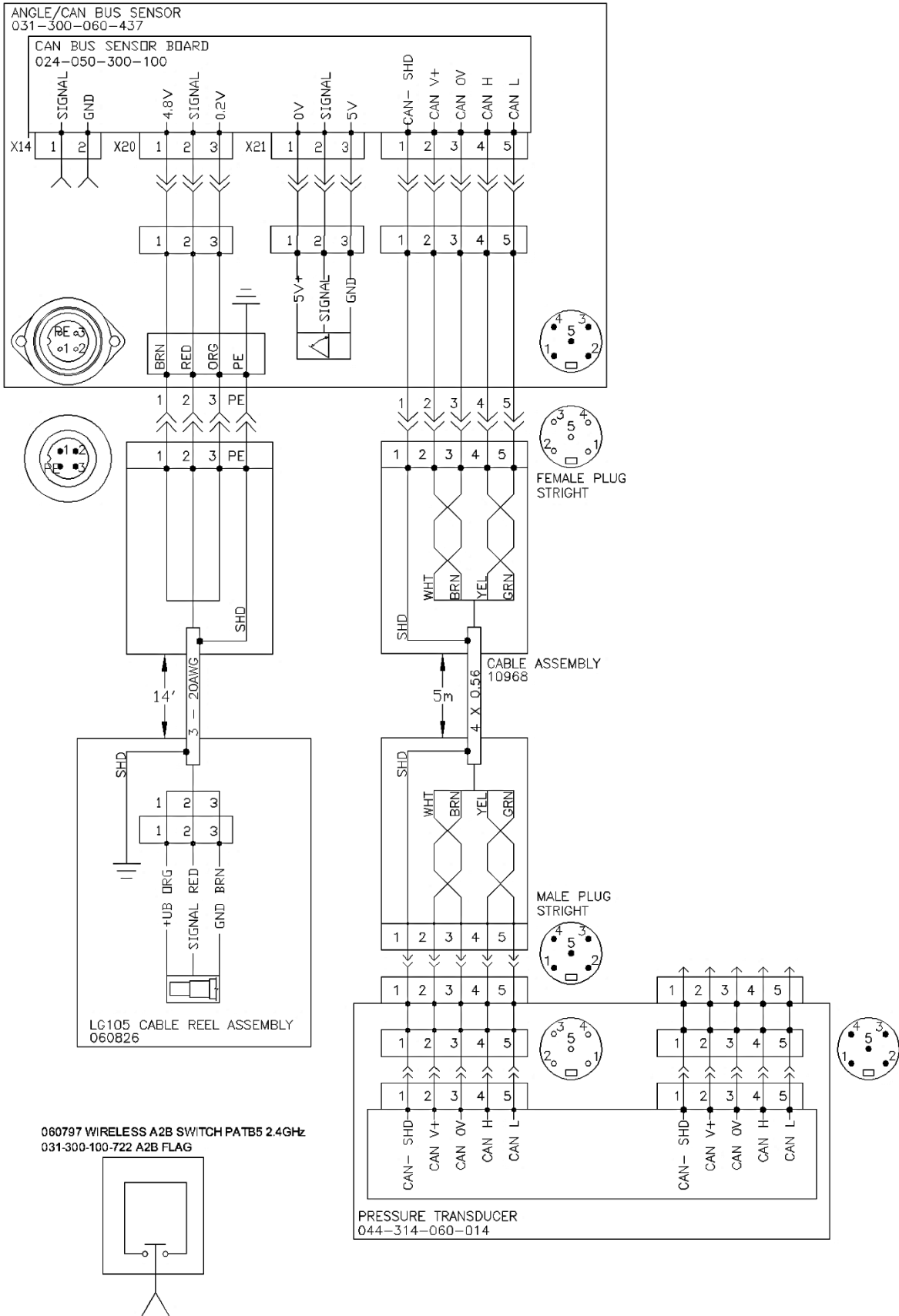

15.3 HARDWIRED A2B WIRING DIAGRAM

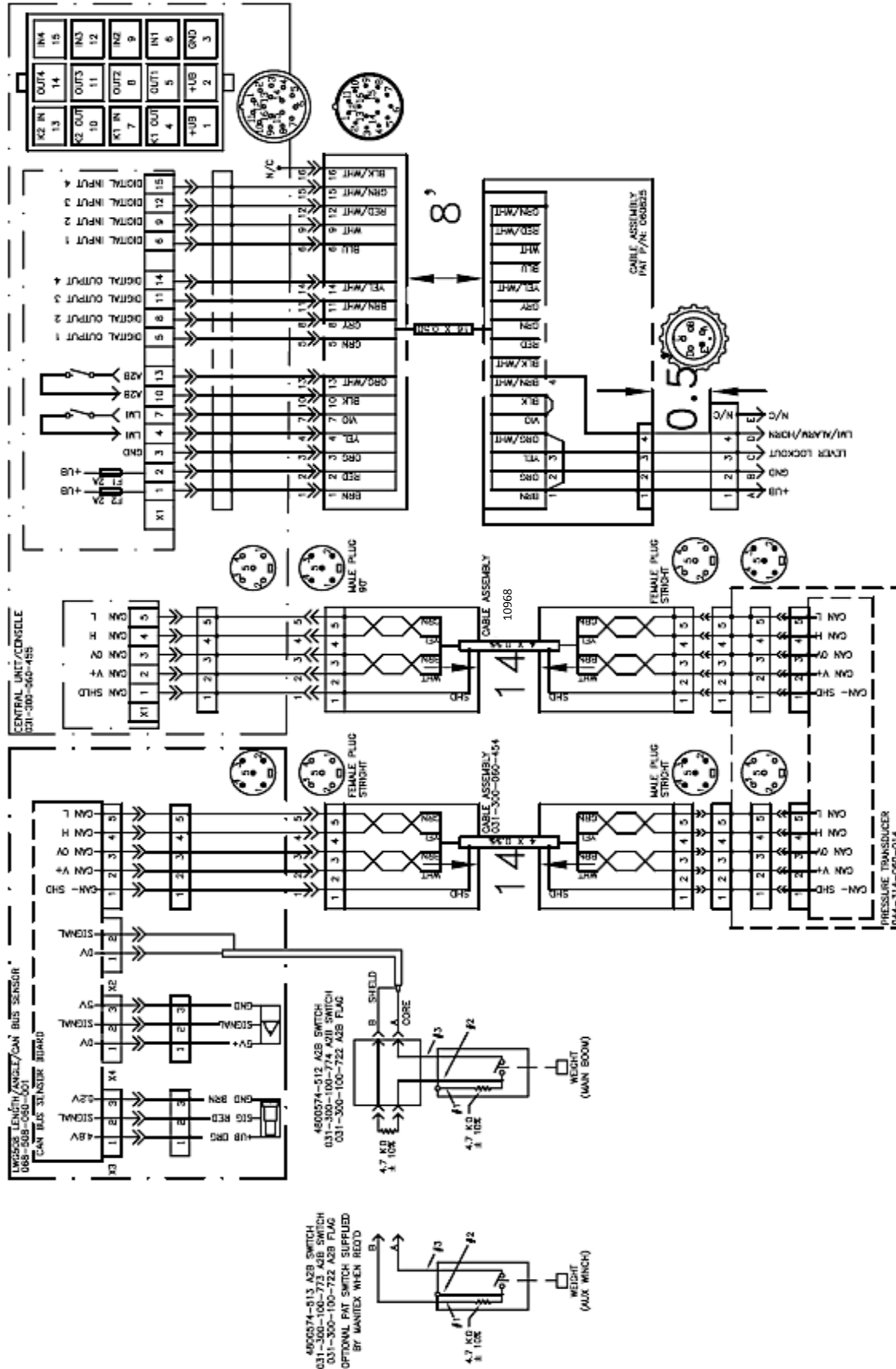

16 SPARE PART LISTINGS

16.1 CONSOLE/CENTRAL UNIT PART NO. 031-300-060-455

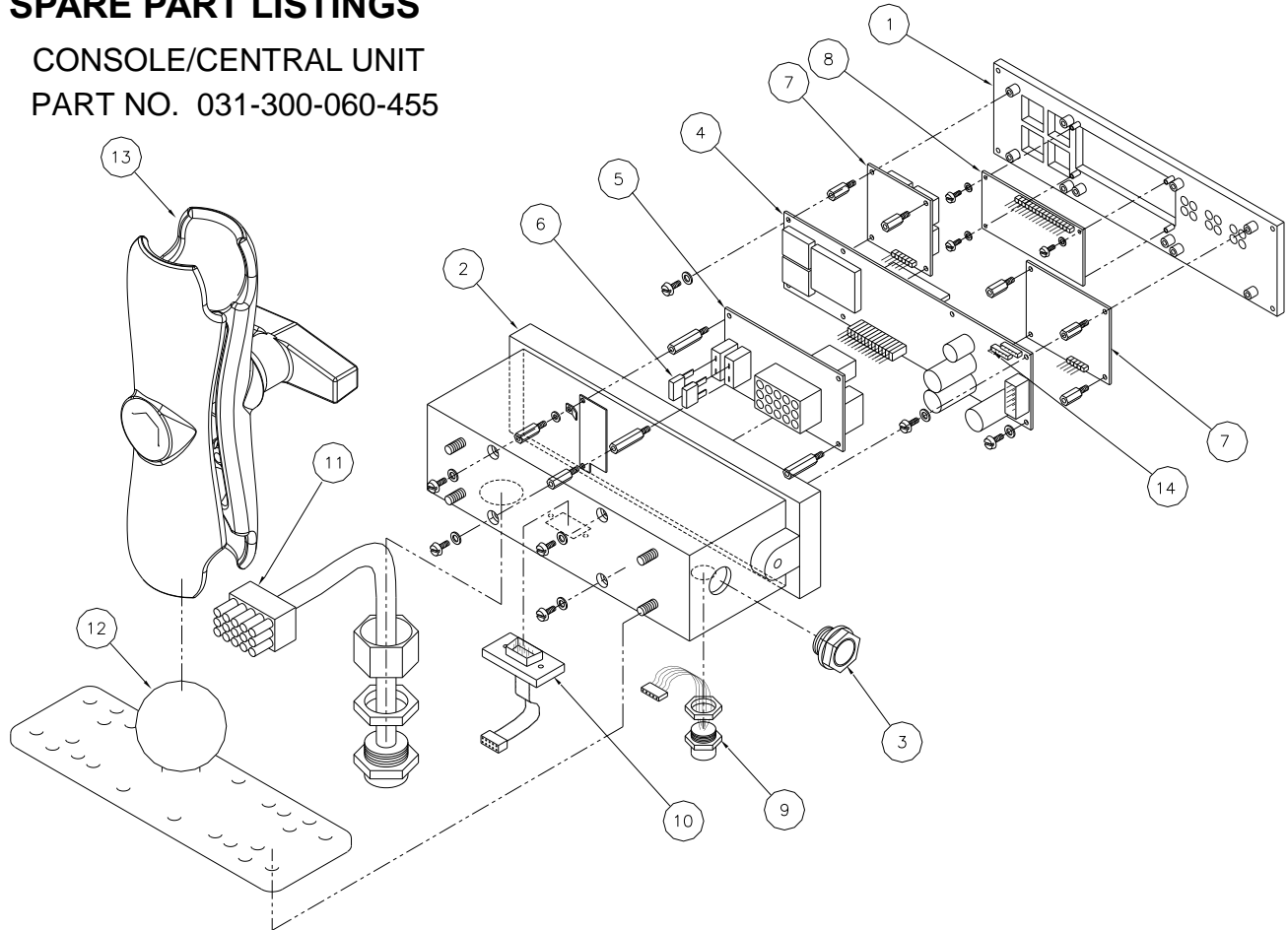

NO.	PART NO.	QTY	DESCRIPTION
1	024-085-100-002	1	FRONTFACE, PREASSEMBLED
2	024-000-050-002	1	HOUSING, DS85
3	024-000-100-095	1	CENTRAL UNIT ACCY, MEMBRANE VENT, PG11
4	024-050-300-101	1	MAINBOARD, CAN w/o FLASH E-EPROM
5	024-050-300-106	1	CONNECTION BOARD
6	031-300-050-223	2	FUSE, 2 AMP
7	024-050-300-110	1	KEYBOARD
8	050-000-100-271	1	LC DISPLAY UNIT
9	092-000-060-391	1	CAN BUS CONNECTOR, 5-PIN FEMALE, 120 ohms
10	024-050-290-101	1	RIBBON CABLE ASSY
11	031-300-060-700	1	CABLE ASSEMBLY, W/ GROUND CONNECTIONS
12	031-300-060-696	1	MOUNTING ASSEMBLY, 1.5" BALL
13	031-300-050-624	1	MOUNTING ARM, 4.63" DOUBLE SOCKET FOR 1.5" BALL
14	092-000-060-390	1	CAN BUS TERMINATOR, 120 OHMS



Cable assemblies not included with console:

1. Power Cable assembly (wiring harness)
PART NO. 031-300-060-443
2. CAN bus from console (90° connector) to pressure transducer block PART NO. 031-300-060-453
3. CAN bus from pressure transducer to angle sensor box
PART NO. 10968 *(not shown)

See next page:



1

Power Cable assembly (wiring harness)
PART NO. 031-300-060-443



2

CAN bus from console (90° connector) to pressure
transducer block PART NO. 031-300-060-453



3

CAN bus from pressure transducer to angle sensor box (see below)
PART NO. 10968

16.2 PRESSURE TRANSDUCER BLOCK

DAV314/0014 PART NO. 044-314-060-014



Piston Side

Rod Side

Cutting ring for pressure transducers PART NO. 000-209-140-016
Hydraulic bulkhead adapter 9/16-18 JIC 37° x 16m x 1.5 PART NO. 000-214-600-093

16.3 ANGLE SENSOR BOX PART NO. 031-300-060-437

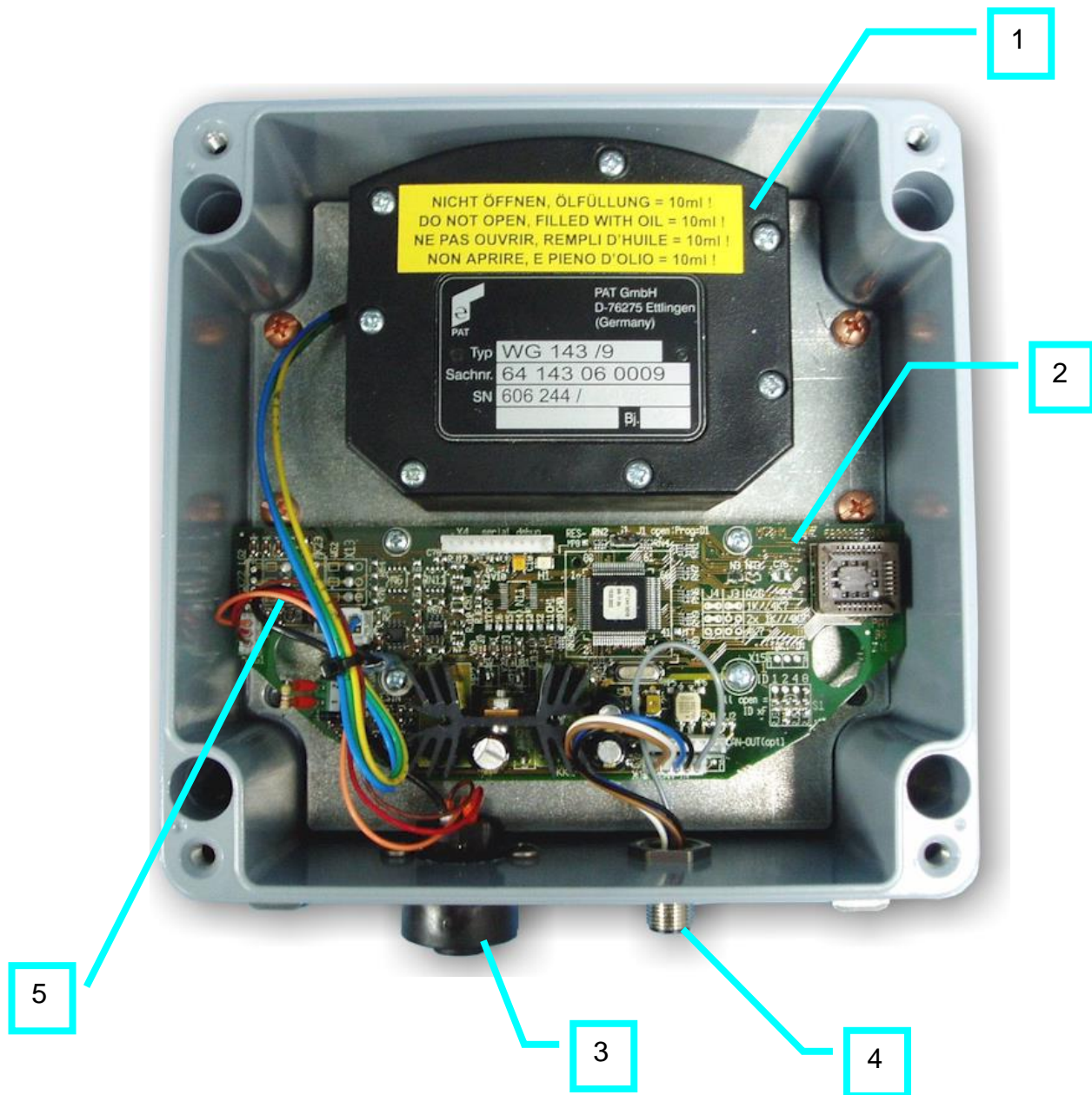

NO.	PART NO.	QTY	DESCRIPTION
1	064-143-060-009	1	SENSOR, ANGLE WG143/9 iFLEX CAN
2	068-000-300-103	1	CAN-BUS CONVERTER BOARD 10-30V
3	932321100	1	CONNECTOR, PANEL MOUNT SOCKET 3 + PE
4	092-000-060-387	1	CONNECTOR, BRAD HARRISON 5-PIN RECPT. MALE
5	092-000-060-382	1	CABLE, 3POL JST-PLUG 15cm

16.4 CABLE REEL ASSEMBLY
PART NO. 060826

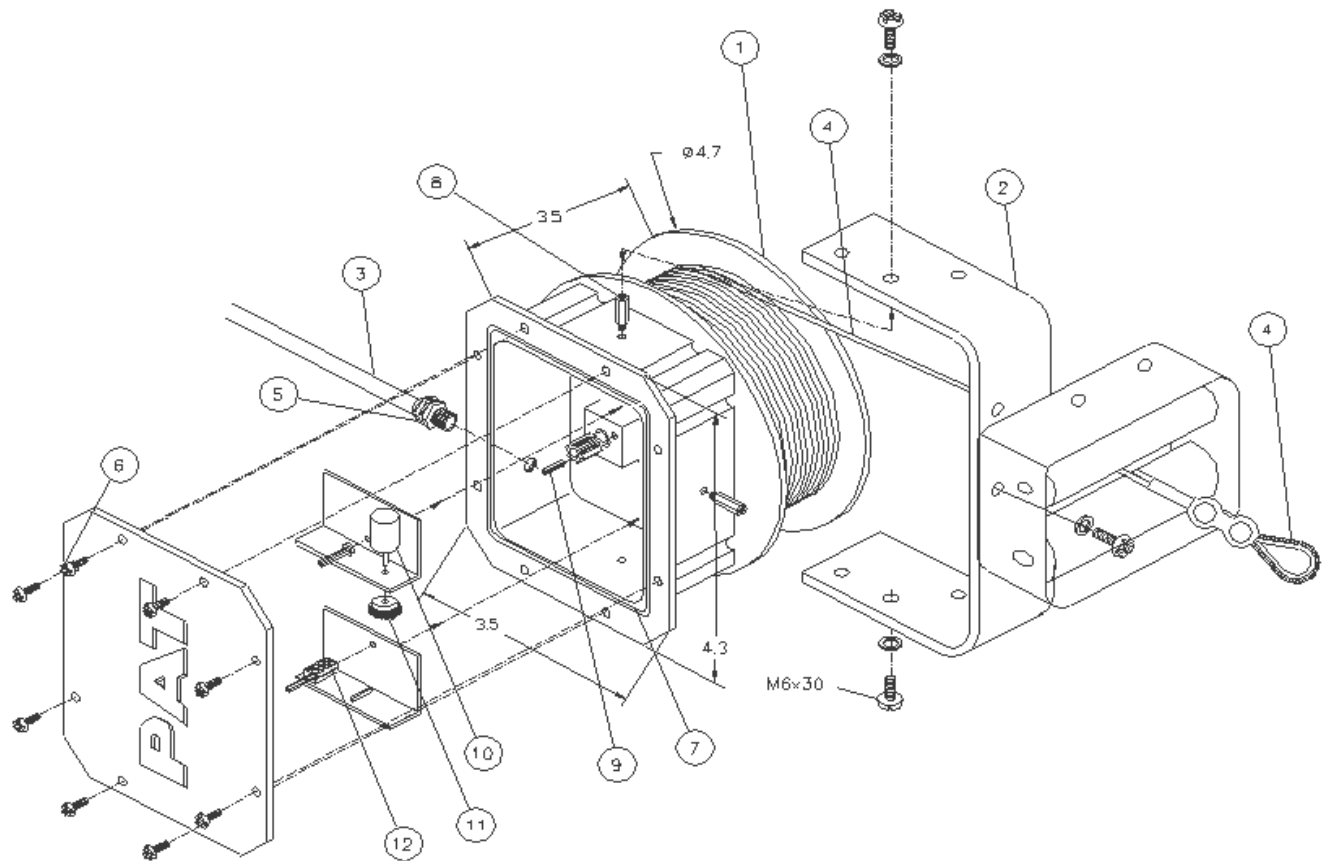

NO.	PART NO.	QTY	DESCRIPTION
1	N/A	1	HARDWARE, DRUM (FACTORY SERVICEABLE)
2	031-300-050-131	1	BRACKET, LG105 WITH CABLE GUIDE
3	031-300-060-374	1	CABLE ASSY, 15' (3 COND. WITH 4 PIN PLUG)
4	060831	1	CABLE ASSY, LENGTH (35') w/ RING TERMINAL & CLAMP
5	024-441-060-409	1	STRAIN RELIEF, PG9 4-6mm YELLOW/WHITE
6	031-300-060-682	1	HARDWARE, LG105 COVER SCREW SET, M4x12
7	209-032-010-501	1	GASKET, O-RING FOR LG105 COVER
8	031-300-060-683	4	HARDWARE, LG105 EXTERNAL SET
9	031-300-060-684	1	HARDWARE, LG105 INTERNAL SET
10	031-300-060-578	1	LENGTH POT ASSY, LG105/0006
11	067-105-110-001	1	GEAR WHEEL, LG105/2, WORM WHEEL COMPLETE W/FIXING MATERIAL
12	031-300-100-462	1	TERMINAL STRIP, 4 POS.

16.5 CABLE REEL ASSEMBLY
LWG508 PART NO. 068-508-060-001

NO.	PART NO.	QTY	DESCRIPTION
1	031-300-060-468	1	CABLE REEL ACCY, LWG508 DRUM BODY W/LENGTH CABLE
2	000-673-020-002	139'	LENGTH SENSOR CABLE
3	068-000-300-103	1	BOARD, LENGTH AND ANGLE OUTPUT
4	067-000-300-012	1	LENGTH POTENTIOMETER LWG508
5	064-143-060-009	1	ANGLE SENSOR, WG143/09
6	068-000-110-107	1	SLIP RING ASSEMBLY 2 CONDUCTOR
7*	006-800-005-001	1	25T GEAR WHEEL
8	068-000-110-038	1	75T GEAR WHEEL
9*	092-000-060-387	1	CONNECTOR, 5 POLE W/WIRES
10*	068-000-100-196	1	LID, BLACK
11*	068-000-110-003	1	CABLE REEL ACCY, GASKET FOR COVER
12*	068-000-110-031	10	CABLE REEL ACCY, SCREW/CAPTIVE

* ITEM NOT SHOWN

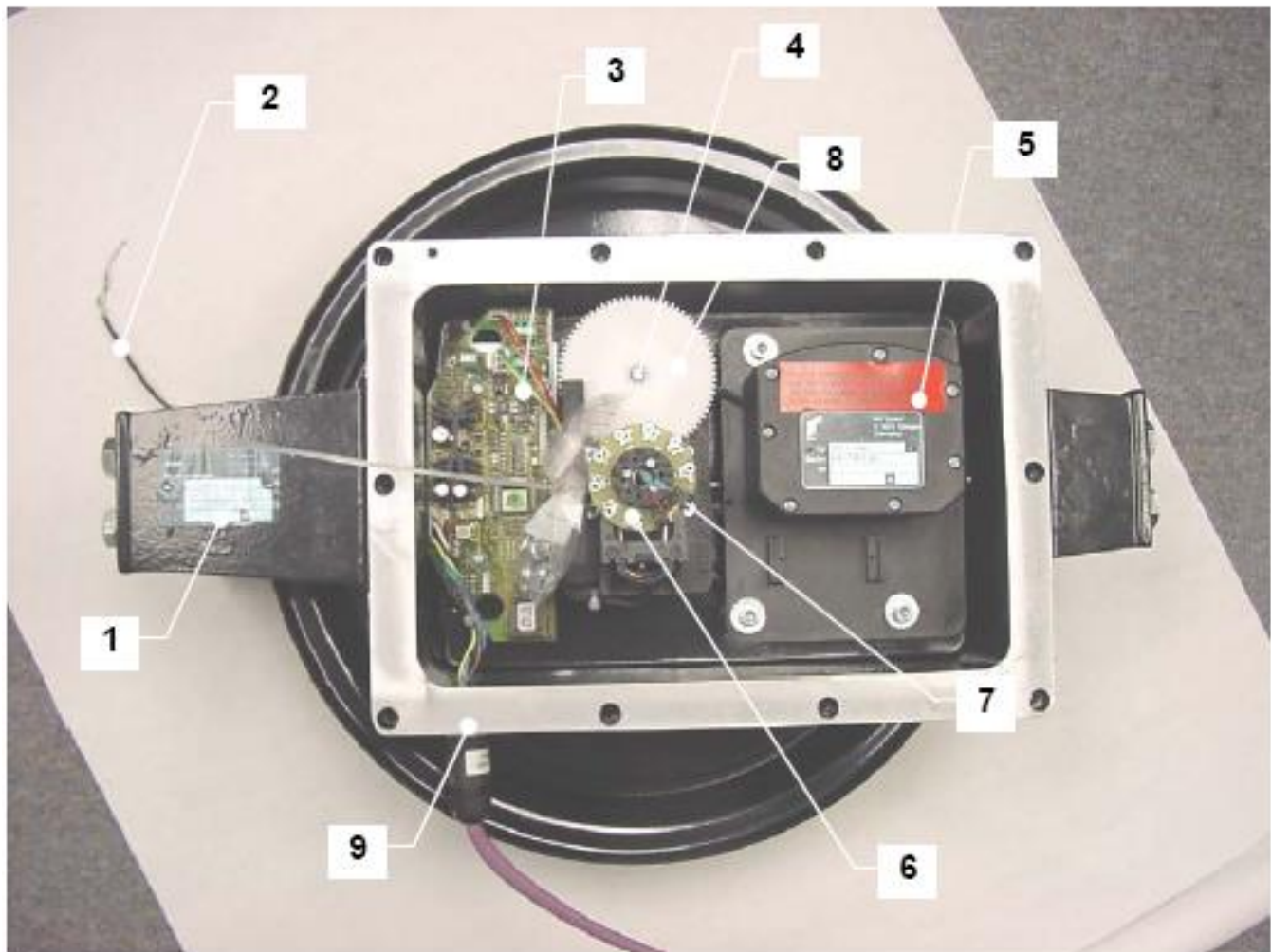



16.6 RADIO A2B

 <p>060864 - Wireless Receiver TRS12 (PATB5 2.4GHz)</p>	 <p>060741 - Wireless A2B Transmitter Assembly (PATB5 2.4GHz)</p>
 <p>031-300-050-536 Card board tube</p>	 <p>031-002-060-022 Radio A2B switch</p>
 <p>031-300-050-276 A2B Mounting standoff</p>	 <p>031-300-050-264 A2B mounting plate</p>
 <p>031-300-210-012 Weight and chain 031-300-100-037 Chain connector, quick link</p>	 <p>031-300-050-272 Lynch pin</p>
 <p>031-300-050-537 Transmitter Battery Cover w/Screws, Gasket, Battery Tubes</p>	 <p>031-300-050-768 Antenna</p>

17 SERVICE SCREEN FOR SENSOR CALIBRATION

17.1 ACTIVATING THE SERVICE SCREEN FOR SENSOR CALIBRATION

Enter the calibrate sensors menu by using the following procedure:

To start function press  + 

 CALIB. SENSORS
SENSOR OUTPUTS



Press  to calibrate sensors.



 USER No.
EXIT

Press  to enter user number.

 USER No: 54545

At this point, a five digit Authorization Number must be entered.



Use  and  keys to increase and decrease each digit. Use  to confirm entry.

Having successfully entered a valid password, use  and  keys to mark the piston-side, the rod-side zero setting, and length, and angle calibration. The calibration sensor screen will remain available and accessible without entering the user number until system is power off,

17.2 ZERO-SETTING THE TRANSDUCER INPUTS

NOTE: The only thing adjustable for the pressure transducers is the zero point, which is the voltage the transducer outputs when there is no (zero) pressure sensed.

CAUTION: Ensure there is no pressure in the hydraulic line when disconnecting the hoses from pressure transducers.

Use  and  keys to mark the piston-side **or** rod-side zero setting.

 PISTON PRESS
ROD PRESS

The piston-side or rod-side zero-point setting function is activated

as shown in the screens above selected sensor.

 ROD PRESS
MB LENGTH

and pressing  to calibrate



 CALIB. SENSORS ?
YES

to continue, press .

 YES
NO

to calibrate, press .

BOOM DOWN COMPL
DISCONNECT HYDR

When the boom is in the rest position bleed to continue,
press . Press  to continue.

 DISCONNECT HYDR
OK

Press  to continue.

 OK
EXIT



Press  to calibrate.

Check the sensor outputs screen to check the zero point. At the zero point, the millivolt should be 0500 ±20mV.

0500mV 0494mV
0.0 PS 0.0 PS

17.3 CALIBRATE LENGTH INPUT

For extended boom, the adjustment is done by software as described in 6 section [Length Sensor Adjustment Procedure](#).

Use  and  keys to mark the main boom length calibration.

 MB LENGTH
MB ANGLE

Pressing  to activate length calibration.

 CALIB. SENSORS ?
YES

to continue, press .

 YES
NO

to calibrate, press .

 FULLY RETRACT
MAINBOO 30.6 ft

fully retract the main boom, to continue, press .

 MAINBOO 30.6 ft
OK

acknowledge main boom fully retracted, to continue, press .

 OK
EXIT

Press  to calibrate.

 FULLY EXTEND
MAINBOO 100 ft

fully extend the main boom, to continue, press .

 MAINBOO 100 ft
OK

acknowledge main boom fully extended, to continue, press .

 OK
EXIT

Press  to calibrate.

Check the sensor outputs screen retracted and extended lengths. Retracted length should be correct at 0500mV and extended boom length will depend on the model.



0502mV	2025mV
30.6 ft	55.7°

Extended main boom _____, millivolts _____

17.4 CALIBRATE ANGLE INPUT

The angle sensor is calibrated at four different reference angles of approximately 0°, 40°, 60°, and 70°. The "BOOM T" specifies the calibration angle the boom should be moved to. When "CHANG" is displayed by the actual boom angle, the boom angle maybe calibrated. The previously calibrated angles define the reference angles.

NOTE: This process should be repeated if sensor is ever removed or replaced.

Use  and  keys to mark the main boom angle calibration.

 MB ANGLE
--

Press  to activate angle calibration.-

 CALIB. ANGLE ?
YES

To continue, press .

 YES
NO

to calibrate, press .



 BOOM T 0.0 DEG
CHANG 0.0 DEG

(BOOM T: is calibration angle, CHANG is actual angle) move boom so the CHANGE angle is with in $\pm 2^\circ$ of the BOOM T angle. to continue press .

 CHANGE 0.0 DEG
OK

Mark CHANGE and press  to change angle calibration. Mark, OK if no change is necessary.

 BOOM T 0.0 DEG
CHANGE DEG

Use  and  keys to change angle to match the BOOM T angle. Press  to calibrate the main boom angle.



 BOOM T 40.3 DEG
-0.1 DEG

Move boom so the CHANGE angle is with in $\pm 2^\circ$ of the BOOM T angle. to continue, press .

 BOOM T 40.3 DEG
CHANG 40.0 DEG

Mark CHANGE and press  to change angle calibration. Mark OK if no change is necessary.

BOOM T	40.3	DEG
CHANG	40.0	DEG

Use  and  keys to change CHANGE angle to match the BOOM T angle. Press  to calibrate the main boom angle.



BOOM T	65.6	DEG
CHANG	40.3	DEG

Move boom so the CHANGE angle is within $\pm 2^\circ$ of the BOOM T angle. to continue, press .

BOOM T	65.6	DEG
CHANG	65.6	DEG

Mark CHANGE and press  to change angle calibration. Mark, OK if no change is necessary.

BOOM T	65.6	DEG
CHANG	65.6	DEG

Use  and  keys to change CHANGE angle to match the BOOM T angle. Press  to calibrate the main boom angle.



BOOM T	74.9	DEG
CHANG	65.4	DEG

Move boom so the CHANGE angle is within $\pm 2^\circ$ of the BOOM T angle. to continue, press .

BOOM T	74.9	DEG
CHANG	76.1	DEG

Mark CHANGE and press  to change angle calibration. Mark, OK if no change is necessary.

BOOM T	74.9	DEG
CHANGE	75.0	DEG

Use  and  keys to change CHANGE angle to match the BOOM T angle. Press  to calibrate the main boom angle.

SAVE CALIB. ?
YES

To continue, press .

YES
NO

Mark YES and press  to change angle calibration. Mark, NO if the changes are not to be saved.

OK
EXIT

Mark OK and press  to save changes.

Using a calibrated inclinometer placed flat on the main boom, verify that the indicated boom angle matches the measured boom angle within +/- 0.2 degrees.

Check the sensor outputs screen for 0°, 45°, 60°, and 70°

0502mV	2025mV
30.6 ft	55.7°

main boom angle	millivolts
0°	
45°	
60°	
70°	

18 ERROR CODES

The following Error Code Table gives a brief description of Error Codes elimination. Refer to the noted sections for detailed Troubleshooting information.

Error Code	Error	Possible Cause	Elimination
E01	Fallen below radius range or angle range exceeded	<ul style="list-style-type: none"> • Fallen below the minimum radius or gone past the maximum angle specified in the respective load chart due to luffing up the boom too far 	<ul style="list-style-type: none"> • Luff down the boom to a radius or angle specified in the load chart.
E02	Radius range exceeded or fallen below angle range	<ul style="list-style-type: none"> • Gone past the maximum radius or fallen below the minimum angle specified in the respective load chart due to luffing down the boom too far 	<ul style="list-style-type: none"> • Luff up the boom to a radius or angle specified in the load chart.
E03	Non-permitted slewing zone (no load area)	<ul style="list-style-type: none"> • The slewing zone with load is not permitted 	<ul style="list-style-type: none"> • Slew to permitted area
E04	Operating mode not acknowledged or non permitted slewing zone	<ul style="list-style-type: none"> • An incorrect operating mode has been selected • The boom is in a non-permitted slewing zone 	<ul style="list-style-type: none"> • Set the correct operating mode for the operating configuration in question. Refer to Operator's Handbook. • Slew the boom to a permitted area. Refer to Section 8.
E05	Prohibited length range	<ul style="list-style-type: none"> • Boom has been extended either too far or not far enough, e.g. if it is prohibited to go beyond a certain maximum boom length or with load curves for jibs where the main boom has to be extended to a certain length • Length sensor adjustment has changed, e.g. the cable slid off the length sensor reel. 	<ul style="list-style-type: none"> • Extend/retract boom to the correct length • Retract boom. Check the prestress of the cable reel (cable must be taut). Open the length sensor and carefully turn the length sensor pot counterclockwise until the detent by means of a screw driver
		<ul style="list-style-type: none"> • Clutch between length sensor pot and drive is defective 	<ul style="list-style-type: none"> • Replace the complete clutch including drive wheel and adjust length sensor pot as described above

Error Code	Error	Possible Cause	Elimination
E11	Fallen below lower limit value for measuring channel "length main boom"	<ul style="list-style-type: none"> Length potentiometer is defective 	<ul style="list-style-type: none"> Replace length potentiometer, see section Length Sensing
E12	Fallen below the lower limit value in the measuring channel "pressure piston side"	<ul style="list-style-type: none"> Pressure transducer is defective. 	<ul style="list-style-type: none"> Replace pressure transducer, see section Pressure Sensing
E13	Fallen below lower limit value in the measuring channel "pressure rod side"	<ul style="list-style-type: none"> refer to E12 	<ul style="list-style-type: none"> refer to E12
E14	Fallen below lower limit value in measuring channel "force"	<ul style="list-style-type: none"> Force transducer defective 	<ul style="list-style-type: none"> Replace force transducer Replace sensor unit
E15	Fallen below lower limit value in measuring channel "angle main boom"	<ul style="list-style-type: none"> Angle potentiometer defective 	<ul style="list-style-type: none"> Replace angle sensor, see section Angle Sensing
E16	Fallen below lower limit value in measuring channel "angle 2"	<ul style="list-style-type: none"> Angle potentiometer defective 	<ul style="list-style-type: none"> Refer to E-15
E17	Fallen below lower limit value "length telescope I (+II)"	<ul style="list-style-type: none"> Length potentiometer defective 	<ul style="list-style-type: none"> Replace length sensor, see section Length Sensing
E1A	Fallen below lower limit value in measuring channel "slewing angle 1".	<ul style="list-style-type: none"> Cable between the central unit and the slewing angle sensor defective or loose. Slewing angle potentiometer is defective 	<ul style="list-style-type: none"> Check cable as well as plugs, replace, if need be. Replace slewing angle sensor
E1B	Fallen below lower limit value in measuring channel "slewing angle 2"	<ul style="list-style-type: none"> refer to E1A 	<ul style="list-style-type: none"> refer to E1A
E21	Upper limit value in measuring channel "main boom length" has been exceeded.	<ul style="list-style-type: none"> refer to E11 	<ul style="list-style-type: none"> refer to E11

Error Code	Error	Possible Cause	Elimination
E22	Upper limit value in measuring channel "pressure piston side" has been exceeded	<ul style="list-style-type: none"> refer to E12 	<ul style="list-style-type: none"> refer to E12
E23	Upper limit value in measuring channel "pressure rod side" has been exceeded.	<ul style="list-style-type: none"> refer to E12 	<ul style="list-style-type: none"> refer to E12
E24	Upper limit value in measuring channel "force" has been exceeded.	<ul style="list-style-type: none"> refer to E14 	<ul style="list-style-type: none"> refer to E14
E25	Upper limit value in measuring channel "main boom angle" has been exceeded.	<ul style="list-style-type: none"> refer to E15 	<ul style="list-style-type: none"> refer to E15
E26	Upper limit value in measuring channel "angle 2" has been exceeded.	<ul style="list-style-type: none"> refer to E16 	<ul style="list-style-type: none"> refer to E16
E27	Upper limit value in measuring channel "length telescope I (+II) has been exceeded.	<ul style="list-style-type: none"> refer to E17 	<ul style="list-style-type: none"> refer to E17
E2A	Upper limit value in measuring channel "slewing angle 1" has been exceeded	<ul style="list-style-type: none"> refer to E1A 	<ul style="list-style-type: none"> refer to E1A
E2B	Upper limit value in measuring channel "slewing angle 2" has been exceeded	<ul style="list-style-type: none"> refer to E1A 	<ul style="list-style-type: none"> refer to E1A
E31	Error in the system program	<ul style="list-style-type: none"> The system program file is defective. Flash-EPROM defective 	<ul style="list-style-type: none"> Upload valid system software Replace central unit
E37	Error in the logical program flow	<ul style="list-style-type: none"> System program file is defective Flash-EPROM defective 	<ul style="list-style-type: none"> Upload valid system software Replace central unit
E38	System program and crane data file do not match.	<ul style="list-style-type: none"> The system program in the LMI does not match to the programming in the crane data file 	<ul style="list-style-type: none"> Upload valid system program file or the valid crane data file
E39	System program and load chart file do not match	<ul style="list-style-type: none"> The system program in the LMI and the programming in the load chart file do not match. 	<ul style="list-style-type: none"> Upload valid system program file or the valid load chart file

Error Code	Error	Possible Cause	Elimination
E43	Error in the write/read memory, (RAM)	<ul style="list-style-type: none"> Write/read memory (RAM) or central unit defective. 	<ul style="list-style-type: none"> Replace central unit
E47	<p>Error in the monitored write/read memory.</p> <p>The CRC verification of the monitored write/read memory provides an incoherent result</p>	<ul style="list-style-type: none"> The CRC sign of the monitored write/read memory is wrong The buffer battery is discharged (< 2V at 1kOhm). Central unit defective. 	<ul style="list-style-type: none"> Restart the LMI Replace buffer battery on the central unit. Replace central unit
E51	Error in the crane data file	<ul style="list-style-type: none"> No valid data in the crane data file. Flash-EPROM defective 	<ul style="list-style-type: none"> Upload valid crane data file Replace central unit
E52	Error in load chart file.	<ul style="list-style-type: none"> No valid data in the load chart file Flash-EPROM defective 	<ul style="list-style-type: none"> Upload valid load chart file Replace central unit
E56	Error in crane data file.	<ul style="list-style-type: none"> No valid data in the crane data file during calibration. Flash-EPROM defective 	<ul style="list-style-type: none"> Restore or upload valid crane data file Replace central unit
E57	Error in serial crane data file.	<ul style="list-style-type: none"> Calibration data file does not contain valid data. Flash-EPROM defective 	<ul style="list-style-type: none"> Upload calibration data file Replace central unit
E60	The number of the selected File base and the programmed value are not identical	<ul style="list-style-type: none"> No valid data in the load chart file Base number not programmed Load chart file wrongly programmed 	<ul style="list-style-type: none"> Upload valid load chart file Program the correct base number (1 for base 1, 2 for base 2) Check base programming in the load chart file.
E61	Error in the CAN bus data transfer for all CAN units	<ul style="list-style-type: none"> CAN Bus cable between the central unit and the sensor units defective or not connected. Short circuit in a CAN Bus cable 	<ul style="list-style-type: none"> Check the connection between the central unit and the sensor units (wiring harness). See section CAN-Bus Communication Replace Can Bus cable

Error Code	Error	Possible Cause	Elimination
		<ul style="list-style-type: none"> • Can bus port in the central unit defective 	<ul style="list-style-type: none"> • Replace the central unit
		<ul style="list-style-type: none"> • Blown fuse in console 	<ul style="list-style-type: none"> • Replace 2 amp fuse
E62	Error in the can bus data transfer of the pressure transducer sensor unit	<ul style="list-style-type: none"> • Cable between the central unit and the sensor unit defective or not connected. 	<ul style="list-style-type: none"> • Check the cable to the sensor unit (wiring harness). See section CAN-Bus Communication
		<ul style="list-style-type: none"> • Blown fuse in console • Sensor unit is defective 	<ul style="list-style-type: none"> • Replace 2 amp fuse • Replace the sensor unit
E63	Error in the can bus pressure transducer sensor unit	<ul style="list-style-type: none"> • The analog values of the sensor unit are invalid 	<ul style="list-style-type: none"> • Replace the sensor unit See section CAN-Bus Communication .
E64	Error in the can bus data transfer of the length/angle sensor unit	<ul style="list-style-type: none"> • Cable between the pressure transducer and cable reel defective or not connected. • Sensor unit is defective 	<ul style="list-style-type: none"> • Check the cable to the sensor unit. See section CAN-Bus Communication • Replace the electronic board in the cable reel, see section CAN-Bus Communication
E65	Error in the can bus length/angle sensor unit	<ul style="list-style-type: none"> • Angle sensor defective • Length sensor defective • Sensor unit is defective 	<ul style="list-style-type: none"> • Replace the angle sensor, see section CAN-Bus Communication • Replace the length sensor, see section CAN-Bus Communication • Replace the electronic board in the cable reel, see section CAN-Bus Communication
E66	Error in the can bus data transfer of the 2 nd length/angle sensor unit	<ul style="list-style-type: none"> • See E62 	<ul style="list-style-type: none"> • See E62
E67	Error in the can bus of the 2 nd length /angle sensor unit	<ul style="list-style-type: none"> • See E63 	<ul style="list-style-type: none"> • See E63
E68	Error in the can bus data transfer of the force sensor unit	<ul style="list-style-type: none"> • See E62 	<ul style="list-style-type: none"> • See E62
E69	Error in the can bus force sensor unit	<ul style="list-style-type: none"> • See E63 	<ul style="list-style-type: none"> • See E63

Error Code	Error	Possible Cause	Elimination
E80	Error in the slewing angle measurement	<ul style="list-style-type: none"> The difference between the average of the slewing angle and one of the wipers of the slewing potentiometer is out of the tolerance 	<ul style="list-style-type: none"> See section Slewing Sensing
E84	Wrong rigging condition.	<ul style="list-style-type: none"> The selected rigging condition is not contained in the crane data file. 	<ul style="list-style-type: none"> Select another rigging condition Check the programming in the crane data file.
E85	Error in the radius determination	<ul style="list-style-type: none"> The computed radius is too small (negative deflection) 	<ul style="list-style-type: none"> Check the programming in the crane data file.
E89	Operating mode switchover with load.	<ul style="list-style-type: none"> The operating mode on the console has been switched over with the boom loaded. 	<ul style="list-style-type: none"> Select operating mode without load on the boom
EAB	Short circuit in the A2B switch circuit	<ul style="list-style-type: none"> Short circuit in the A2B switch Short circuit in the cable to the A2B switch 	<ul style="list-style-type: none"> Replace A2B switch Replace cable to the A2B switch
EAC	A2B switch circuit disconnected	<ul style="list-style-type: none"> Disconnected cable in the A2B switch Disconnected cable to the A2B switch 	<ul style="list-style-type: none"> Connect or replace cable in the A2B switch Connect or replace cable to the A2B switch
EAD	No valid A2B switch status	<ul style="list-style-type: none"> Sensor wrong function CAN bus delay 	<ul style="list-style-type: none"> Replace A2B switch Replace cable to the A2B switch

Note:

If an error message is displayed which is not contained in above list, please contact the PAT service department.

19 TROUBLESHOOTING MOISTURE

The PAT iFLEX5 LMI contains electronic components in various locations, such as central unit, sensors, junction boxes etc. These internal components cannot be designed to withstand exposure to moisture over a longer period of time. For this reason, the housings of the components are water protected according to IP 65. If you find water or moisture inside any of the housings, the source for the water ingress has to be detected and corrected to ensure proper operation.

There are two major possibilities for the occurrence of excessive moisture inside an enclosure:

- 1) Water ingress
- 2) Condensation

This outline gives instructions for detecting the cause for excessive moisture by using simple troubleshooting methods and how to prevent the moisture ingress from happening again.

19.1 WATER INGRESS

There are 6 possibilities for water to enter an enclosure:

- 1) Spray Cleaning
- 2) Missing / Loose Screws
- 3) Bent Lid
- 4) Defective Gasket
- 5) Loose Strain Relieves
- 6) Water Entry Through External Cabling

It is possible to find out the source of water ingress by going through the following steps and ruling out one possibility after the other until the cause is identified:

1) Spray Cleaning

The enclosures used for the PAT LMI system are water protected to IP 65. This means protection against the environment, such as rain. However, through the use of spray cleaner at short distances, it is possible to force water through the gasket or strain relieves. For this reason, avoid spraying any components from short distances with spray cleaners. Convey this fact to any member of a maintenance crew.

2) Missing / Loose Screws

All screws have to be present and to be equally tight to ensure water protection of the enclosure. If there are screws missing, replace them. If no screw is missing, check the tightness. If any were loose, then open all screws and then re-tighten them equally.

3) Bent Lid

An enclosure will only seal correctly if the lid is not bent. To check this, loosen all screws of the lid, take the lid off the box and visually inspect it for deflection. If the lid is bent or damaged, it needs to be replaced. Try to determine what has caused the lid to be bent and eliminate the reason for that. Order a new lid through your PAT representative.

4) Defective Gasket

The gasket underneath the lid seals the unit. The gasket needs to be in good condition in order to seal correctly. If the gasket is torn, brittle or severely bent, it needs to be replaced. Order a new gasket through your PAT representative.

5) Loose Strain Reliefs

The strain reliefs allow cabling to enter the box without allowing water to enter it. The strain reliefs have to be correctly tightened in order to do this. Check the tightness by taking the external cable into one hand and carefully trying to turn it. If the internal wires turn with the outer cable, the strain relief is loose. Get a new grommet (insert) through your PAT representative and replace the existing one with the new one. Tighten the strain relief correctly. Note: Whenever a strain relief is opened, i.e. to replace a cable, a new grommet needs to be used. Never re-use any grommet or the strain relief will not seal properly!

6) Water Entry Through External Cabling

Even with a tight strain relief, water may still enter the box through the inside of the cable. In this case, you have to find out why and where water enters the cable. Look for damages to the cable itself and inspect the opposite side of the cable. In example, if the cable comes from a connector that is full of water, the water will run through the inside of the cable and fill up the central unit, too.

19.2 CONDENSATION

In a climate with high humidity and rapidly changing temperatures, condensation can happen inside any enclosure, usually the larger the volume of the box, the more likely. In this case, water drops build up on the inner components when humid air is trapped inside the box. With condensation, water tightness is not a problem – the box is sealed just fine, which is what prevents the trapped air from exiting the box. There are two ways to deal with condensation:

1. If the volume is very small, a desiccant bag might be able to soak up the air's humidity.
2. If the effect is more severe, the only way to get rid of this effect is then to give the box the ability to breath without sacrificing its water tightness. Contact your PAT representative for breathing elements to than can be added to the box and will help to reduce the effects of humid climates.