



**HIRSCHMANN**

**PAT**

**LOAD MOMENT INDICATOR**

**DS 350GW**

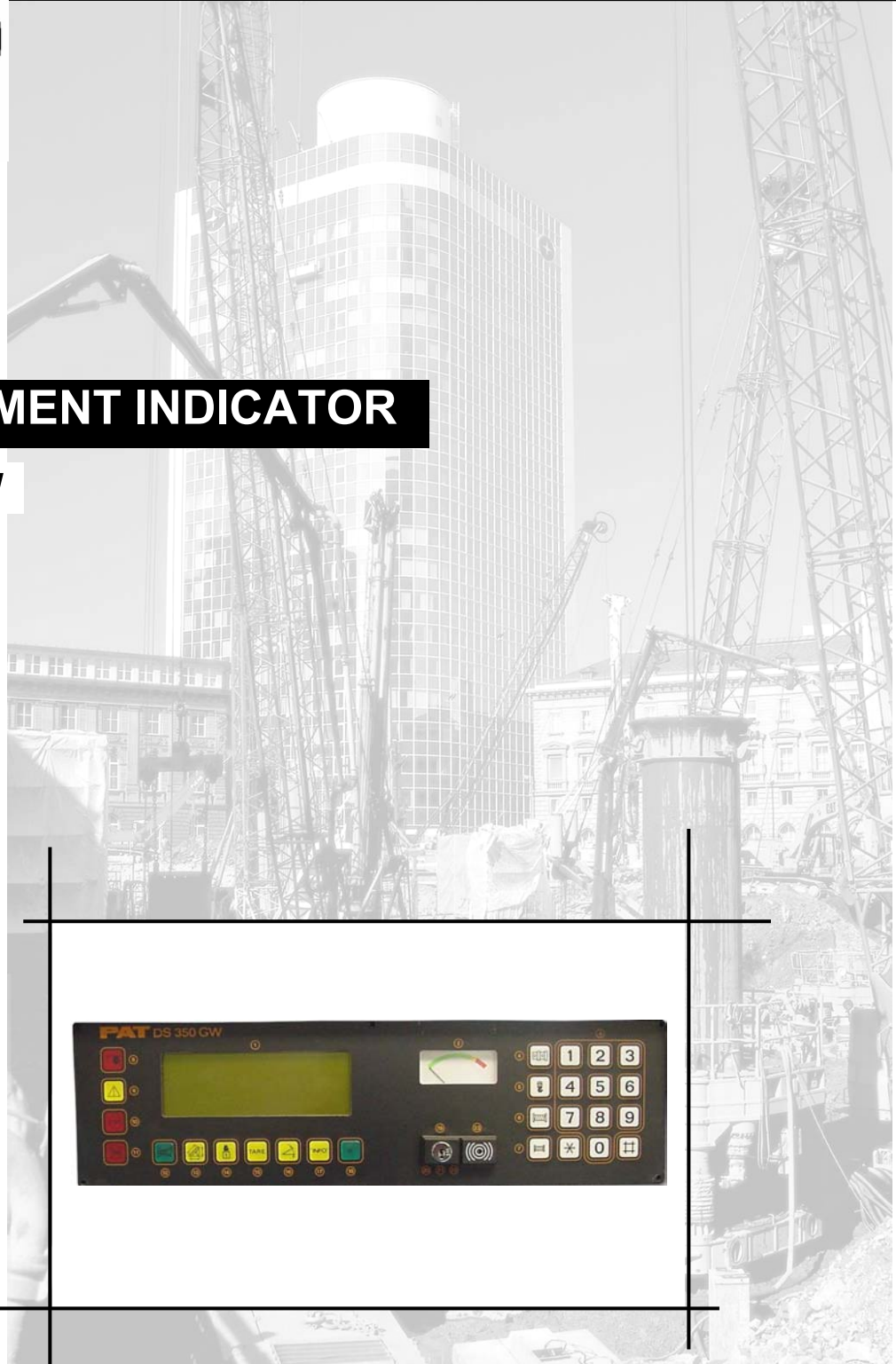

**OPERATOR'S MANUAL**

5<sup>TH</sup> Edition 1996 OPRTHDB-DS350GW

---

*Copyright 1993 by PIETZSCH Automatisierungstechnik GmbH*

**Fifth Edition 5/16/1996**

OPRTH08-DS350GW

## NOTICE

The information in this document is subject to change without notice.

*PAT makes no warranty of any kind with regard to this material, including, but not limited to, the implied warranties of merchantability and fitness for a particular purpose.*

*PAT shall not be liable for errors contained herein or for incidental or consequential damages in connection with the furnishing, performance, or use of this manual.*

This document contains proprietary information which is protected by copyright. All rights are reserved. No part of this document may be photocopied, reproduced, or translated to another language without the prior written consent of PAT.



# PART 1

---

## TABLE OF CONTENTS

---

<b>1</b>	<b>General Information</b>	<b>1</b>
<hr/>		
<b>2</b>	<b>Warnings</b>	<b>2</b>
<hr/>		
<b>3</b>	<b>System Description</b>	<b>3</b>
3.1	Operating Console	5
3.2	System Function	6
<hr/>		
<b>4</b>	<b>System's Operation</b>	<b>7</b>
4.1	Pre-Setup	7
4.2	Information Run	12
4.3	Programming Procedure	26
4.3.1	Programming of Operating Mode	26
4.3.2	Activating and Setting of Boom Angle Preset Limits	33
<hr/>		
<b>5</b>	<b>Pre-Operation Inspection and Calibration Verification</b>	<b>38</b>
<hr/>		
<b>6</b>	<b>Service and Maintenance</b>	<b>44</b>
<hr/>		
<b>7</b>	<b>Troubleshooting</b>	<b>45</b>
<hr/>		



# 1 GENERAL INFORMATION

The PAT Load Moment Indicator<sup>1)</sup> (LMI) DS 350 GW has been designed to provide the crane operator with the essential information required to enable the machine to be used within its design parameters.

Using various sensing devices, the Load Moment Indicator monitors various crane functions and provides the operator with a continuous reading of the crane's capacity. The readings continuously change as the crane moves through the motions needed to make the lift.

The LMI provides the operator with information regarding the length and angle of the boom, tip height, working radius, rated load and the total calculated weight being lifted by the crane.

If non permitted conditions are approached, the DS 350 GW Load Moment Indicator will warn the operator by sounding an audible alarm, lighting a warning light and locking out those functions that may aggravate the crane's condition

1) **LOAD MOMENT:** generally the product of a force and its moment arm; specifically, the product of the load and the load-radius. Used in the determination of the lifting capacity of a crane.

## 2 WARNINGS

The LMI is an operational aid which warns a crane operator of approaching overload conditions and also warns of overhoist conditions which could cause damage to equipment and personnel.

**The device is not, and shall not, be a substitute for good operator judgement, experience and use of accepted safe crane operating procedures.**

**The responsibility for the safe operation of the crane shall remain with the crane operator who shall ensure that all warnings and instructions supplied are fully understood and observed.**

Prior to operating the crane, the operator must carefully and thoroughly read and understand the information in this manual to ensure that he knows the operation and limitations of the indicator and crane.

Proper functioning is dependent upon proper daily inspection and observations of the operating instructions set forth in this manual. We draw your attention to section 5 of this handbook.

### WARNING

The display (6) will only aid the operator when the LMI is properly programmed and the proper load capacity chart and operating code are selected for the crane configuration being utilized. To prevent property damage or serious bodily injury or death to personnel, ensure the LMI is properly programmed before operating the crane.

### WARNING

This system is equipped with an override key on the central microprocessor unit. This key switch bypasses control lever lock-out function of load moment indicator device. The switch may only be used by authorized personnel during emergency situations. Failure to follow this instruction may result in property damage and/or personal injury.

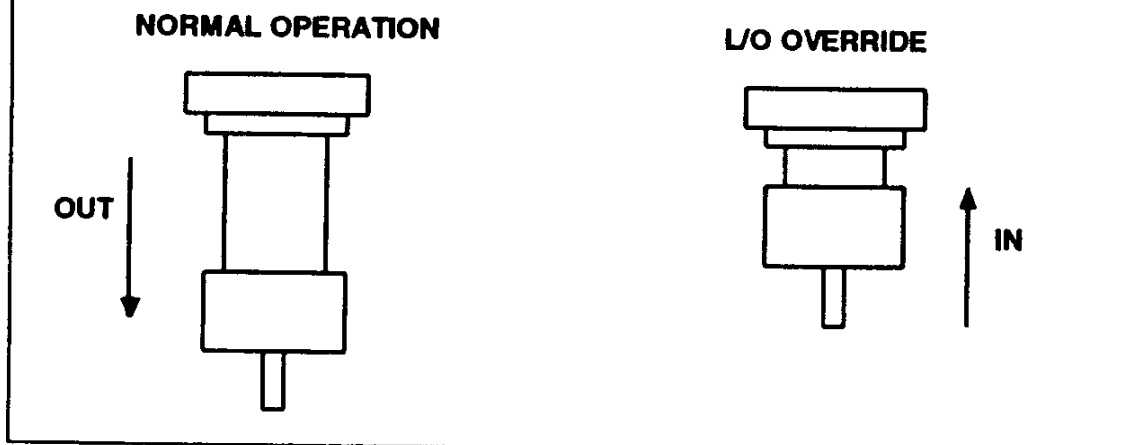



## **3 SYSTEM DESCRIPTION**

The PAT Load Moment Indicator DS 350 GW consists of a central micro processor unit, operating console, length/angle sensor, pressure transducers and anti-two-block switches.

The system operates on the principle of reference/actual comparison. The actual value, resulting from the force or pressure measurement is compared with the reference data, stored in the central processor memory and evaluated in the micro processor. When limits are reached, an overload warning signal is generated at the operator's console. At the same time, the dangerous crane movements, such as hoist up, telescope out and boom down, will be stopped.

The fixed data regarding the crane, such as load capacity charts, boom weights, centers of gravity and dimensions are stored in memory chips in the central processor unit. This data is the reference information used to calculate the operating conditions.

Boom length and boom angle are registered by the length/angle sensor, mounted inside the cable reel which is mounted on the boom. The boom length is measured by the cable reel cable which also serves as an electrical conductor for the anti-two-block switches.

The crane load is measured by pressure transducers attached to the piston and rod side of the lift cylinders.

**Fig. 1: Components of PAT LMI System DS 350 GW**

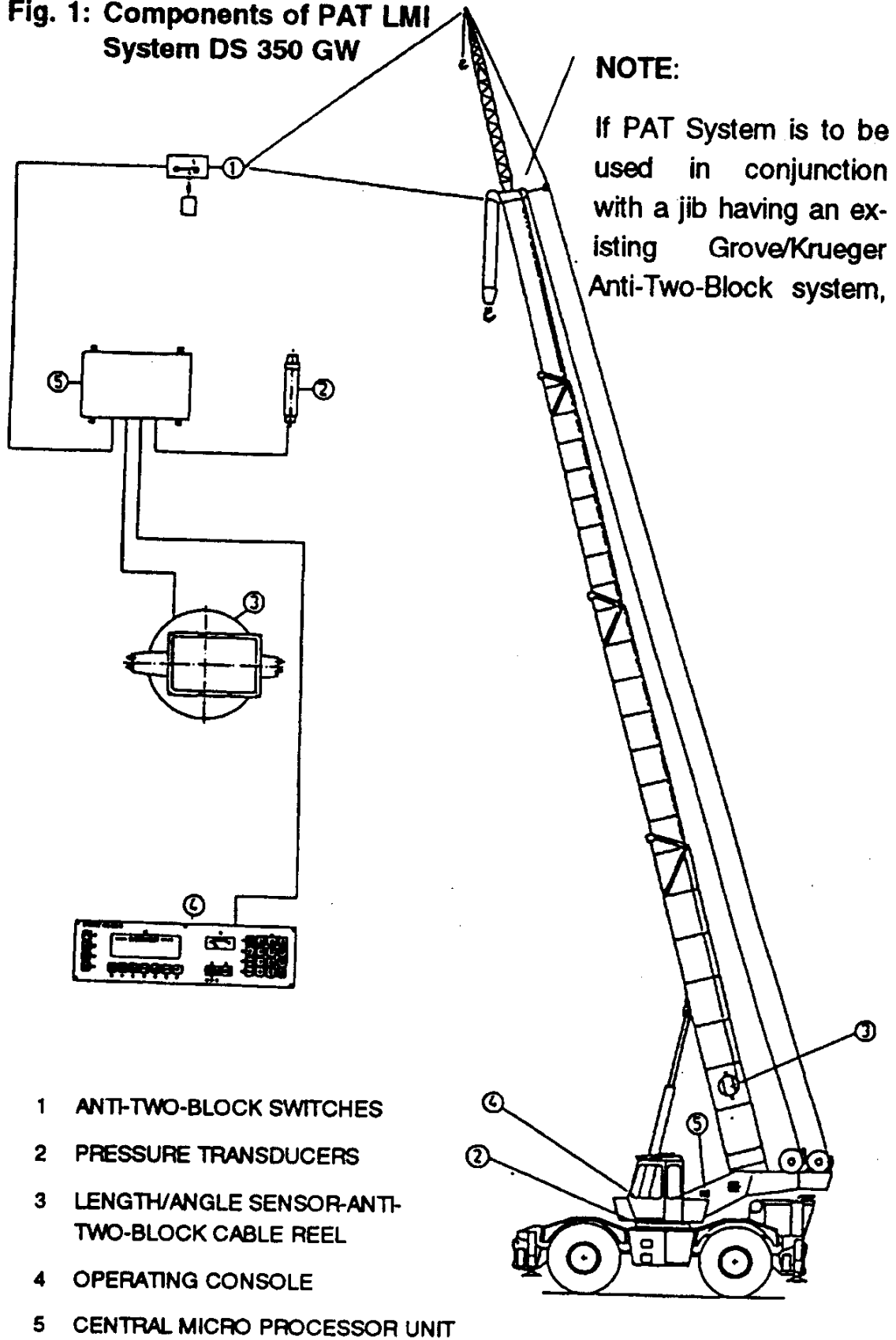

## LIGHTBAR

The PAT Lightbar is a supplementary indicator for the standard PAT Load Moment Indicator systems. It displays the load moment in form of a bargraph. The lightbar is located in the operator's cab in front of the operator.

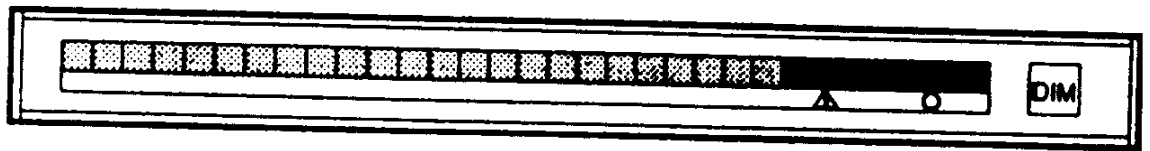

This indicator displays how much of the crane capacity is being used. As the crane is moved through its various motions, the bargraph will constantly change.

The range of the bargraph is divided into 3 areas:

- the green area is the normal working area,
- the yellow prewarning area shows the remaining portion of the rated load capacity and the bargraph indicates the approach to the overload condition,
- the red area shows that the maximum rated load capacity is exceeded.

***Note: Operating within the red area is not permitted.***

### **Brightness adjustment:**

In order to adapt the PAT Lightbar's brightness to the lighting conditions of the environment a DIM-switch is installed on the right hand side of the display. When actuating the DIM-switch the brightness increases. After having exceeded the maximum brightness value the display turns back to the minimum brightness value.



## 3.1 OPERATING CONSOLE

The console has 2 functions:

- terminal for input of instructions to the system by the crane operator
- display of important data, information and instructions

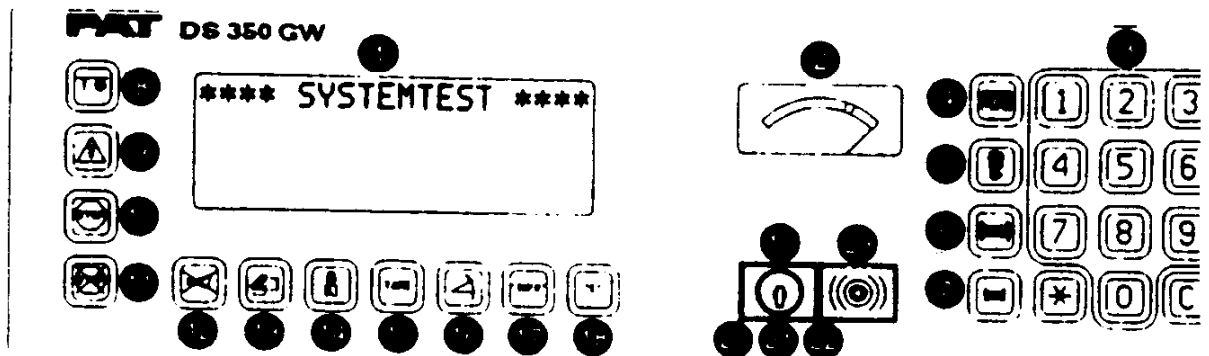
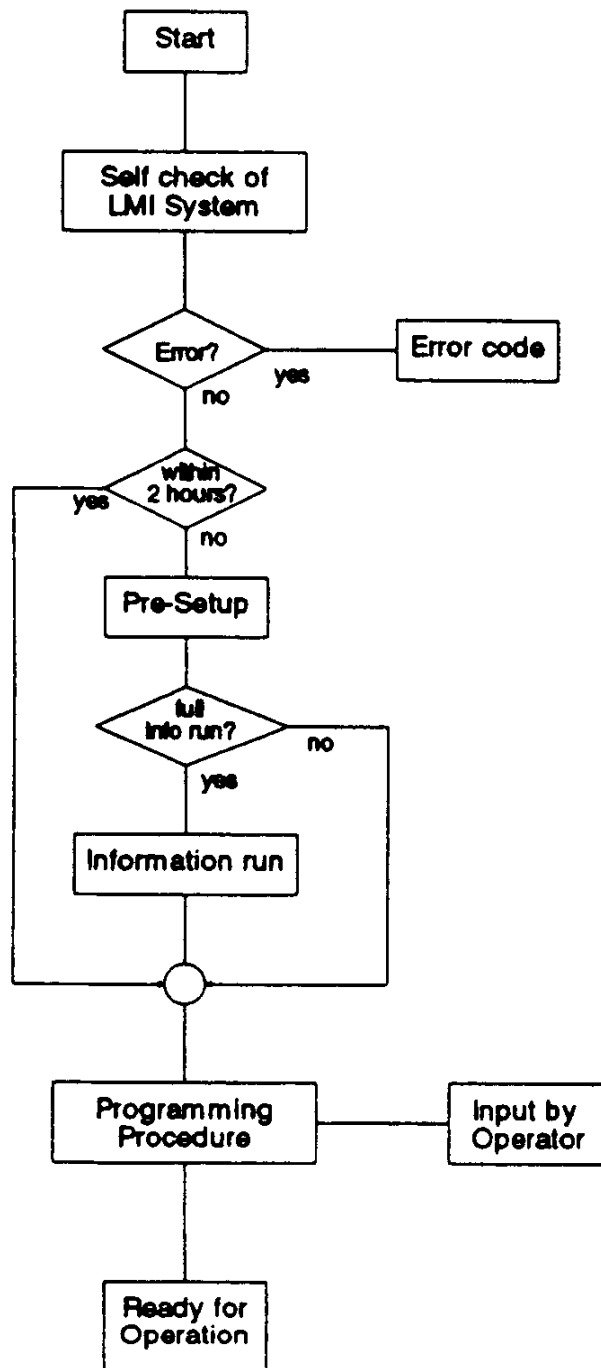

Fig. 2: Operating Console

- |                                |                                     |
|--------------------------------|-------------------------------------|
| 1 Display                      | 13 Button "Boom Data"               |
| 2 Load Moment Indicator        | 14 Button "load Indication"         |
| 3 Keypad                       | 15 Button "Tare"                    |
| 4 Button "Operating Code"      | 16 Button "Boom Angle Preset Limit" |
| 5 Button "Reeving"             | 17 Button "Info"                    |
| 6 Button "Main Hoist"          | 18 Button "Enter"                   |
| 7 Button "Aux. Hoist"          | 19 Key Switch                       |
| 8 Anti-2-Block Alarm Light     | 20 By-Pass Anti-2-Block Lockout     |
| 9 Load Moment Prewarning Light | 21 Normal Operation                 |
| 10 Load Moment Limit Light     | 22 By-Pass LMI Lockout              |
| 11 Override Key Warning Light  | 23 Audible Alarm                    |
| 12 Button "Horn Off"           |                                     |

## 3.2 SYSTEM FUNCTION

The PAT Load Moment Indicator (LMI) works with a user guide system that simplifies the operation of the crane and the LMI system. The system run during the start up phase is shown in the following block diagram.



After ignition of the engine the system starts with an automatic test of all lamps, the audible alarm and the complete LMI system.

In case of system malfunction an error code number will be displayed on the console.

After restarting the engine within 2 hours, the system will by-pass "Pre-Setup" and "Information run".

Basic system information for crane operator will be displayed.

Experienced operators who are familiar with the LMI system can by-pass the info run

The system will display information and directions which the operator will follow by using the respective function of the key.

The system is in the programming procedure. The operator has to set the LMI to the configuration of the crane.

The system is ready for operation

## 4 SYSTEM'S OPERATION

During the startup phase the crane operator will receive information about the function and meaning of the various elements of the console. This process will also remind the crane operator to follow the respective operating instructions.

During the pre-setup phase the crane operator will receive general information about his responsibility by operating the crane.

If the operator is experienced and totally familiar with the function and operation of the system he can go directly to the programming procedure at the end of this PRE-SETUP phase.

**When the crane engine is restarted after less than approximately two hours, the Pre-Setup and Information Run will be skipped.**

### 4.1 Pre-Setup

The PRE-SETUP is a simple step by step procedure. The information will be displayed until a button is pressed to call for the next info step. The PRE-SETUP is followed by the Info Run or by the programming phase.

In the following the system start will be explained step by step.

## MESSAGE 1

ON KEYPAD #3  
PUSH "1" FOR ENGLISH

After the ignition of the crane has been activated and the system has passed through the system test without errors, the console will display this phrase alternating in English, Spanish, French, German or other languages with the corresponding number.

With the button "1", "2", "3" or "4" on the keypad (# 3) the crane operator can select the English, Spanish, French or German language. The language does not have any influence on the function of the system.

*Instruction: Push Button "1", "2", "3" or "4" of Keypad depending on the desired language*



## MESSAGE 2

DISPLAY IS NOW IN  
ENGLISH  
TO CONFIRM \*PUSH "E"

The display will now show the selected language.

After completion of programming procedure, the language can be changed anytime by pressing the INFO button (17) and selecting the desired language

at Message # 1 and confirming at Message # 2. After 15 seconds without pressing any button, the readout will display operating information and instructions in the desired language.

Button "E" has to be pressed to accept this language.

*Instruction: Push Button "E"*





### MESSAGE 3

FIND OPERATOR  
MANUALS  
READ AND UNDERSTAND  
\* PUSH "INFO"

Prior to operating, the crane operator shall carefully and thoroughly read and understand the crane load capacity charts and the information contained in the manuals for the crane and the LMI, to ensure that the operator knows the operation and limitations of the crane and the LMI.

*Instruction: Push Button "INFO"*



### MESSAGE 4

THE LMI SYSTEM IS AN  
OPERATIONAL AID  
WHICH CAN FAIL  
\* PUSH "INFO"

The load moment indicator (LMI) is a system which supports an operator in his action to operate the crane.

**But the system cannot be 100% fail-safe and not all causes for danger can be recognized at the same time.**

*Instruction: Push Button "INFO"*



**MESSAGE 5**

CONSULT AND OPERATE  
ACCORDING TO IN CAB  
LOAD CAPACITY CHARTS  
\* PUSH "INFO"

For the loading capacity of the crane only the load capacity charts are relevant. The operator shall also observe the operating instructions in the load capacity charts.

The load values in the load capacity chart shall under no circumstances be exceeded. It is essential to select the correct operating code number which is also printed in the load capacity chart.

*Instruction: Push Button "INFO"*

**MESSAGE 6**

YOU ARE ALWAYS  
RESPONSIBLE FOR  
YOUR LIFT OPERATIONS  
\* PUSH "INFO"

*The operator is entirely responsible for safe crane operation.*

He has to make sure that the crane is in good condition and that he works on firm and level supporting surface. The operator shall fully acquaint himself with the most recent government regulations and industry standards relevant to safe craning operations.

*Instruction: Push Button "INFO"*



**MESSAGE 7**

IF IN DOUBT CONSULT  
THE OPERATOR MANUALS  
BEFORE OPERATING THE  
CRANE \* PUSH "INFO"

If there is anything unclear or if there are doubts about operating the crane or LMI, the operator shall consult the operator manuals before operating the crane.

*Instruction: Push Button "INFO"*

**MESSAGE 8**

FOR FULL INFO RUN  
\* PUSH "INFO"  
TO SKIP CONSOLE DE-  
SCRIPTION \* PUSH "E"

Only if you are totally familiar with the LMI system functions may you go directly to the programming procedure by pressing the button "E".

*Instruction:*

*Push Button "INFO" for Info run*



*Push Button "E" to skip over Info run*



## 4.2 Information Run

The Information Run is a simple step by step procedure. The information will be displayed until a button is pressed to call for the next info step. The Information Run is followed by the programming phase.

### MESSAGE 1

YOU WILL NOW GET A  
DESCRIPTION OF THE  
CONSOLE

\* PUSH "INFO"

A description of all elements of the front plate such as display, controls, switches and buttons is given.

*Instruction: Push Button "INFO"*



### MESSAGE 2

DESCRIPTION IS MADE  
ACCORDING TO #1 TO  
#23 ON CONSOLE

\* PUSH "INFO"

The description of the info run follows the reference numbers. The numbers are printed on the front plate of the console next to the various operation and information elements, such as display, lights, switches, buttons.

*Instruction: Push Button "INFO"*



### MESSAGE 3

REF #1: DISPLAY FOR  
INFO/LOAD/BOOM/ERROR  
CODE DATA  
\* PUSH "INFO"

MAX. LOAD 4,800lbs  
ACT. LOAD 3,400lbs  
RADIUS 115.3ft  
12 FALLS ■OP.MOD0001

*Display will be in units corresponding to load capacity charts*

The DISPLAY (1) will show technical information as well as operating information and instructions for the operator.

During crane operation the readout will display max. load, actual load, radius, number of falls (parts of line) and the operating code. Radius is used if the used load capacity chart is radius related. In case of an angle related load capacity chart (jib), boom angle is displayed instead of radius.

*Instruction: Push Button "INFO"*



### MESSAGE 4

REF #2: DISPLAY OF  
LOAD MOMENT  
\* PUSH "INFO"

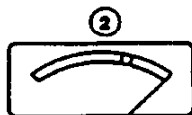

The load moment will be displayed in the INDICATOR (2). This meter displays how much of the crane's rated capacity is being used. As the crane is moved through its various motions, the percent of load moment will constantly change on the display.

The meter is divided into 3 areas:

- a green area is the normal working area
- a yellow prewarning area shows the remaining portion of the rated load capacity and the meter needle indicates the approach to the overload condition
- a red area shows that the maximum rated load capacity is exceeded.

**Operating within the red area is not permitted.**

*Instruction: Push Button "INFO"*



**MESSAGE 5**

REF #3: KEYPAD TO  
ENTER CODE NO. AC-  
CORDING TO FUNCTION  
BUTTON \* PUSH "INFO"

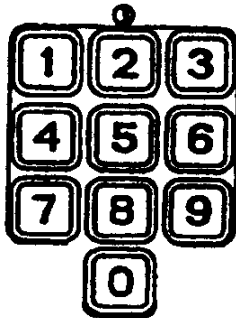

The KEYPAD (3) buttons 1 to 0 are used to select the languages, the operating mode and the number of falls (parts of line) or other functions.



*Instruction: Push Button "INFO"*

**MESSAGE 6**

REF #4: OPERATING  
CODE BUTTON REFER  
TO LOAD CAPACITY  
CHART \* PUSH "INFO"

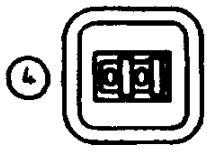

The OPERATING CODE BUTTON (4) is used to activate the programming procedure.

*Refer to programming procedure in chapter 4.3.1*



*Instruction: Push Button "INFO"*

**WARNING**

**The correct setting is of utmost importance for the proper function of the system and the crane. Therefore only operators who are thoroughly familiar with crane load capacity charts and the use and operation of the system shall set the operating code switch.**

**MESSAGE 7**

REF #5: REEVING  
 BUTTON REFER TO  
 OPERATOR'S MANUAL  
 \* PUSH "INFO"

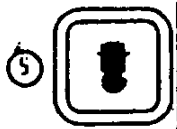

The REEVING BUTTON (5) activates the reeving setting procedure. The keypad (3) is used to provide the load moment indicator with information regarding the number of falls (parts of line) used to reeve the hook block.

After activating the reeving button, the operator has to enter the actual number of falls (parts of line) by pushing the buttons of the keypad (3).

**Caution**

***The correct setting is of utmost importance for the proper function of the system and the crane.***

*Instruction: Push Button "INFO"*

**MESSAGE 8**

REF #6: HOIST SELEC-  
 TOR BUTTON FOR MAIN  
 HOIST  
 \* PUSH "INFO"

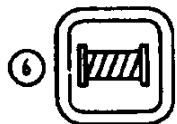

The HOIST SELECTOR BUTTON FOR MAIN HOIST (6) provides the load moment indicator with information regarding the hoist line. This button has to be set when the main hoist is used to lift the load.

*Instruction: Push Button "INFO"*



**MESSAGE 9**

REF #7: HOIST SELEC-  
TOR BUTTON FOR AUXI-  
LIARY HOIST

\* PUSH "INFO"

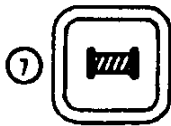

The HOIST SELECTOR BUTTON FOR AUXILIARY HOIST (7) provides the load moment indicator with information regarding the hoist line. This button has to be set when the auxiliary hoist is used to lift the load.

*Instruction: Push Button "INFO"*

**MESSAGE 10**

REF #8: ANTI-TWO-  
BLOCK WARNING LIGHT

\* PUSH "INFO"



The red ANTI-TWO-BLOCK WARNING LIGHT (8) will light up when the anti-two-block limit switch contacts open, indicating that a two-blocking condition is approaching. At the same time the audible alarm will sound.

The following crane movements will be stopped concurrently: hoist up, telescope out, boom down. On units with luffing jib, in addition to above lockouts, the luffing hoist down will be stopped.

*Instruction: Push Button "INFO"*





**MESSAGE 11**

REF #9: LOAD MOMENT  
PREWARNING LIGHT

\* PUSH "INFO"



The yellow LOAD MOMENT PRE-WARNING LIGHT (9) will light up when the load on the crane enters the defined prewarning area. It indicates that an overload condition is approaching.

This means for the operator to continue his crane operation with extreme caution.

The definition and setting of the prewarning area is linked to the data EPROM used in the central unit.

*Instruction: Push Button "INFO"*

**MESSAGE 12**

REF #10: LOAD MOMENT  
LIMIT LIGHT

\* PUSH "INFO"



The red LOAD MOMENT LIMIT LIGHT (10) warns the operator that a rated load condition has been reached. It lights up when the load on the crane reaches the crane load capacity. The audible alarm also sounds when this condition has been reached.

The following crane movements will be stopped concurrently: hoist up, telescope out, boom down. On units with luffing jib, in addition to above lockouts, the luffing hoist down will be stopped.

*Instruction: Push Button "INFO"*



**MESSAGE 13**

REF #11: OVERRIDE  
KEY WARNING LIGHT  
REFER #19, #21, #22  
\* PUSH "INFO"

The red OVERRIDE KEY WARNING LIGHT (11) flashes when the by-pass key switch (19) is turned to key position (22). This switch deactivates the cut-off function of the LMI system.



â

**WARNING**

Should the red override key warning light (11) continue to flash (with the by-pass key switch (19) in the neutral position (21)), the LMI override key switch located on the central processing unit (CPU) has been positioned in the lockout override position. This key switch continually by-passes the control lever lockout function of the load moment indicator device.

Instruction: Push Button "INFO"

**MESSAGE 14**

REF #12: ALARM STOP  
BUTTON  
\* PUSH "INFO"

This ALARM STOP BUTTON (12) allows the audible alarm to be silenced for approximately 15 seconds by pressing this button. Reference audible alarm # 23 at message 25.



12

Instruction: Push Button "INFO"



## MESSAGE 15

REF #13: BOOM DATA  
 BUTTON PRESS FOR  
 DISPLAY ON REF #1  
 \* PUSH "INFO"

ANGLE 55.3° ■LIM.  
 LENGTH 137.4ft ■ 65°  
 HEIGHT 96.5ft ■ 36°  
 02 FALLS 00P.MOD0034

*(Display will be in units corresponding to load capacity charts)*

As long as the BOOM DATA BUTTON (13) is pushed, the display (1) shows the height, boom length, boom angle, number of falls (parts of line) and the operating code. In case of an angle related load capacity chart (jib), radius is displayed instead of angle. If the boom angle preset limits are activated the limit values are also displayed below the LIM symbol.



⑬

Instruction: Push Button "INFO"



## MESSAGE 16 (OPTIONAL)

REF #14: LOAD DATA  
 BUTTON PRESS FOR  
 DISPLAY ON REF #1  
 \* PUSH "INFO"

MAX. LOAD 4,800lbs  
 ACT. LOAD 3,400lbs  
 RADIUS 115.3ft  
 12 FALLS ■OP.MOD0001

*(Display will be in units corresponding to load capacity charts)*

After the LOAD DATA BUTTON (14) has been pushed, the display (1) shows max. load, act. load, radius, number of falls (parts of line) and operating code. In case of an angle related capacity chart (jib), boom angle is displayed instead of radius.



⑭

MAX. LOAD is the maximum permissible load according to the load capacity chart or maximum load permitted by number of falls (parts of line) selected by Reeving button (5). Intermediate values of the load capacity chart are linearly interpolated by the computer.

ACTUAL LOAD is the actual load (gross load). Slings and hook block are included. If boom extension or jib is erected it will be reflected in the actual load displayed, however operator must use weight reduction values, shown in the load capacity chart.

Instruction: Push Button "INFO"



## MESSAGE 17

REF #15: TARE BUTTON  
PRESS FOR DISPLAY OF  
LOAD ON HOOK ON  
REF #1 \* PUSH "INFO"

MAX. LOAD 235,750lbs  
NET LOAD 197,430lbs  
RADIUS 132.3ft  
12 FALLS ■OP.MOD0001

*(Display will be in units corresponding to load capacity charts)*

The TARE BUTTON (15) is used to indicate the *net load* on the display. Net load is the actual load, less <sup>(15)</sup> lifting tackle and hook block. The TARE BUTTON (15) has to be activated before lifting.



After pushing the TARE BUTTON (15) the display shows max. load, net load and radius. Net load display is set to zero (taring). After lifting a load the net load display shows the net load (pay load).

The net load display will change to the actual load display when the boom radius is changed (either by angle or length).

Instruction: Push Button "INFO"



**MESSAGE 18**

REF #16: SET BUTTON  
FOR BOOM ANGLE  
PRESET LIMIT VALUES  
\* PUSH "INFO"

ANGLE 55.3° ■ LIM.  
LENGTH 137.4ft ■ 65°  
HEIGHT 96.5ft ■ 36°  
02 FALLS 00P.M0D0034

*(Display will be in units corresponding to load capacity charts)*

The BOOM ANGLE PRESET LIMIT BUTTON (16) activates the features to recognize and work with boom angle preset limits. After this function has been activated, the button (16) will light up and the display will show the max. and min. angle presets in addition to the boom data for height, length, angle, number of falls (parts of line) and operating code.



⑩

Once these angles are reached, the horn will sound until the boom is moved back into the permissible angle range.

*The procedure to set the boom angle preset limit values is described in detail in chapter 4.3.2*

*Instruction: Push Button "INFO"*

**MESSAGE 19**

REF #17: INFO BUTTON  
FOR SYSTEM INFORMATION RUN  
\* PUSH "INFO"

The INFO BUTTON (17) is used to request information which will be shown on the DISPLAY (1). The directions to use this button will be given through the information \* PUSH "INFO" on the display.



⑩

Any time after completion of the programming procedure by activation of the INFO BUTTON (17) the system will return to message 1 of the

Pre-Setup. In this case the LMI system goes in overload condition. If at any point of the following run no other button is pressed within the next 15 seconds the LMI system and the display will return to normal operating information.

*Instruction: Push Button "INFO"*



## MESSAGE 20

REF #18: ENTER BUT-  
TON ACTIVATE ONLY  
ON REQUEST  
\* PUSH "INFO"



18

The ENTER BUTTON (18) is used to confirm values and data which are used as input for the system. The instruction to use this button will always be given on the display (1).

*Instruction: Push Button "INFO"*



## MESSAGE 21

REF #19: BY-PASS KEY  
SWITCH SEE REF #20  
#21 #22  
\* PUSH "INFO"

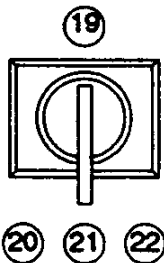

The BY-PASS KEY SWITCH (19) can deactivate the cut-off function of the LMI or anti-two-block momentarily to allow the crane operator to override the control lever lockout. It can be operated only by using the matching key.

The spring-loaded by-pass switch has 3 positions which are further described as follows.

*Instruction: Push Button "INFO"*



## WARNING

Since this switch deactivates the cut-off function of the LMI system and the anti-two-block system, the following instructions shall be adhered to:

- the by-pass key shall be used with discretion, as unwarranted use of it to override the control lever lockout system can result in harm to the crane and danger to property and persons.
- never use the by-pass key to either overload or operate the crane in a range not permissible.

## MESSAGE 22

REF #20:KEY POSITION  
FOR ANTI-TWO-BLOCK  
OVERRIDE  
\* PUSH "INFO"

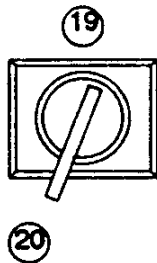

The position (20) by-passes the anti-two-block control lever lockout which does not influence the LMI system. The red warning light (8) and the audible alarm (23) for approaching two-block condition will also come on at all times.

The by-pass key switch is spring-loaded in order to return the switch to the neutral position (21). To activate the switch, it therefore has to be held during its operation.

Instruction: Push Button "INFO"



**MESSAGE 23**

REF #21:KEY POSITION  
FOR NORMAL OPERATION

\* PUSH "INFO"

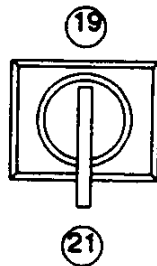

This is the neutral position (21) to which the switch (19) returns because of its spring-loaded mechanism. In this position, the by-pass switch is without influence to the LMI and anti-two-block control lever lockout.

Instruction: Push Button "INFO"

**MESSAGE 24**

REF #22:KEY POSITION  
FOR LMI LOCKOUT  
OVERRIDE

\* PUSH "INFO"



In this position (22), the by-pass key switch (19) deactivates the control lever lockout function of the LMI. All other display, indicating and alarm functions, as well as the control lever lockout function of the anti-two-block system will continue to work. The by-pass switch is spring-loaded in order to return the switch to the neutral position (21). Therefore to activate the switch, it has to be held manually during its operation.

Instruction: Push Button "INFO"





**MESSAGE 25**

REF #23: AUDIBLE  
ALARM

\* PUSH "INFO"



The AUDIBLE ALARM (23) , which sounds during the following conditions:

- overload condition
- approaching two-block condition
- boom angle preset limits are reached
- in case of a malfunction of the LMI system
- in case of an operating error

The alarm can be silenced temporarily by pushing the button (12).

Instruction: Push Button "INFO"

**MESSAGE 26**

END OF INFO RUN

\* PUSH "INFO"

At this point the information procedure is finished.

Instruction: Push Button "INFO"



*With the next procedure the system will now be programmed to the intended operating configuration of the crane.*

## 4.3 PROGRAMMING PROCEDURE

The Pre-Setup procedure or information procedure will automatically be followed by the programming procedure which relies on the correct entry by the crane operator.

This procedure consists of two parts:

- Programming of the LMI to the operating configuration of the crane with the correct operation code for the load capacity chart selected
- Activating and programming of the boom angle pre-set limits (if desired)

For simple operation, the computer guides the operator through the procedure step by step. The operator has to read the information displayed and is instructed to answer questions by using appropriate buttons and keys of the keyboard.

### 4.3.1 Programming of Operating Mode

The Operating Code button (4) is used to activate the programming procedure in order to enter the operating code combination referring to the desired operating code from the load capacity chart.

The correct setting is of utmost importance for the proper function of the system and the crane. Therefore only operators who are thoroughly familiar with the crane load capacity charts, the use and operation of the LMI shall enter the operating code.

#### MESSAGE 1

OPERATING CONDITIONS  
CHANGED ?  
IF YES: PUSH "INFO"  
IF NO : PUSH "E"

This message will only appear, if the engine will be restarted within 2 hours.

When the operating conditions of the crane have changed, the operator has to enter the appropriate operating code.

(After pushing button "INFO", the system will skip over messages 2 and 3)

*If operating conditions have changed, the operator has to Push "INFO"*



(After pushing button "E", the system will skip over messages 2 to 5)

*If operating conditions have not changed, the operator has to Push "E"*



**MESSAGE 2**

OP. MODE SETTING  
PROCEDURE ACTIVATED

\* PUSH "INFO"

This message is displayed, if the operating code button was pushed.

During the mode setting procedure the lamp in the operating code button (4) lights up.

*To obtain the next message press the INFO button (17)*

**MESSAGE 3**

ACTUAL OP. CODE 0001

TO CONFIRM PUSH "E"

TO CHANGE PUSH "INFO"

The actual operating code is displayed. If the operator wants to continue with the displayed code he has to confirm by pushing the button "E".

*To continue with the actual operating code he has to push "E"*

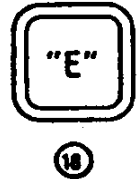

*To enter a new code the operator has to push the "INFO" button (17)*



(After pushing button "E", the system will skip over messages 4 to 6)

**MESSAGE 4**

DETERMINE OPERATING  
CODE FROM IN CAB  
LOAD CAPACITY CHARTS  
\* PUSH "INFO"

The operator has to determine the code number of the intended operating configuration. This number is printed in the load capacity chart e.g. "on outriggers", "on rubber", "with jib", etc..

To obtain the next message  
press the INFO button (17)



20 FT A-FRAME JIB						
	# 0061		# 0062		# 0063	
Main Boom Angle	0' Offset		15' Offset		30' Offset	
	Ref. Radius	Cap. lbs.	Ref. Radius	Cap. lbs.	Ref. Radius	Cap. lbs.
75°	21.5	9,500	25.8	6,100	28.9	4,200
70°	27.8	8,400	31.9	5,450	34.8	3,870
65°	33.9	7,140	37.8	4,850	40.5	3,660
60°	39.7	5,440	43.3	4,400	45.9	3,500

*This is an example of the operating code numbers of a jib with 3 different offset angles (# = LMI Operating Code).*

**MESSAGE 5**

ENTER OP. MODE CODE  
WITH KEYPAD #3  
OP. MODE CODE 0001  
\* PUSH "E"

The operator is instructed to enter the operating code previously determined from the load capacity chart (Refer to message 2) by pressing the buttons on the keypad (3).

To confirm the entry and to  
obtain the next message  
press the "E" button (18)



18

**MESSAGE 6**

CODE 0001: MAIN BOOM  
ON OUTRIGGERS  
- OVER FRONT  
- W/O PPF      PUSH "E"

The console text displays the crane set up selected with the code entered previously.

**WARNING**

**Failure to properly program the LMI with the correct operating code may result in property damage or serious bodily injury or death to personnel. To assure the crane is properly programmed, verify that the operating code and the load capacity chart match the lifting configuration of the crane.**

*To confirm and to obtain the next message press the "E" button (18)*



⑱

**MESSAGE 7**

SELECT DESIRED HOIST  
FOR MAIN      PUSH #6  
FOR AUX.      PUSH #7

The buttons "MAIN HOIST" (6) and "AUX. HOIST" (7) provide the load moment indicator with information regarding the hoist line.

The operator is instructed to enter the information by pressing the button "MAIN HOIST" (6) when the main hoist is used to lift the load

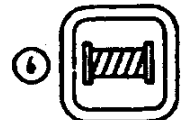

The operator is instructed to enter the information by pressing the button "AUX. HOIST" (7) when the auxiliary hoist is used to lift the load.



**MESSAGE 8**

ACTUAL REEVING  
 01 FALLS  
 TO CONFIRM PUSH "E"  
 TO CHANGE PUSH "INFO"

The actual number of falls (parts of line) is displayed. If the operator wants to continue with the displayed number of falls (parts of line) he has to confirm by pushing the button "E".

During the reeving setting procedure the lamp in the Reeving button (5) lights up

*To continue with the actual number of falls (parts of line) the operator has to push "E" (18)*

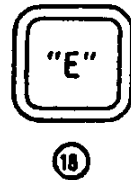

*To enter a new number of falls (parts of line) he has to push the "INFO" button (17)*



(After pushing button "E", the system will skip over message 9)

**MESSAGE 9**

ENTER REEVING:  
 01 FALLS  
 PUSH "E"

The console displays the number of falls (parts of line) entered previously.

*To confirm and to obtain the next message press the "E" button (18)*

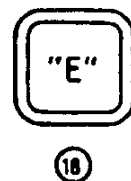

**MESSAGE 10**

ARE OUTRIGGERS  
PROPERLY POSITIONED?  
  
IF YES PUSH "E"

*(Only displayed when "on outrigger" codes are selected)*

Outrigger beams shall be properly positioned and jack cylinders set with tires raised free of crane weight. When equipped with a front jack cylinder, the cylinder shall be set in accordance with the written procedure.

AXLE LOCKOUT / SUS-  
PENSION FUNCTIONING?  
(IF APPLICABLE)  
IF YES PUSH "E"

*(Only displayed when "on rubber" codes are selected)*

Axle Lockout/Suspension must be functioning before lifting on rubber.

*When the above is accomplished confirm by pushing the "E" button (18).*

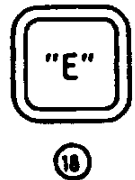
**MESSAGE 11**

IS CRANE LEVEL ON A  
FIRM SUPPORTING  
SURFACE ?  
  
IF YES PUSH "E"

The crane shall be leveled on a firm and level supporting surface.

All rubber lifting depends on proper tire inflation. Consult tire inflation chart on crane.

*When these conditions are met confirm by pushing the "E" button (18).*



**MESSAGE 12**

MAX. LOAD	4,8001bs
ACT. LOAD	3,4001bs
RADIUS	115.3ft
12 FALLS ■OP.MOD0001	

*(Display will be in units corresponding to load capacity charts)*

MAX. LOAD	235,7501bs
ACT. LOAD	197,4301bs
JIB ANGLE	35.7°
3 FALLS ■OP.MOD0021	

The system is now ready to operate. The cut-off of the crane movements will be canceled and the warning lamps and audible alarm will go out.

The display shows the actual values of max. load, actual load, radius, number of falls (parts of line) and the selected operating code.

If the crane is equipped with a luffing fly jib the display will show the actual values of max. load, actual load, angle, number of falls (parts of line) and the selected operating code.



## 4.3.2 Activating and Setting of Boom Angle Preset Limits

The system is equipped with presets for boom angle range selection. There are limits for maximum and minimum boom angle which can be set by the operator as allowed by the crane geometry.

After a system start, the angle limits default to maximum and minimum boom angle as allowed by the crane geometry.

The operator has the possibility to activate only one or both limits. For setting the limit values, the boom has to be moved to the intended limit positions.

For simple operation, the computer guides the operator through the procedure step by step. The operator has to read the displayed information and instructions on the display and he has to answer questions by pushing two buttons.

### Activating the Boom Angle Preset Limits



To select the boom angle preset programming procedure press the button (16).

### Deactivating the Boom Angle Preset Limits

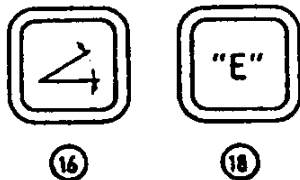

To deactivate the boom angle presets press button (16) and button "E" (18) simultaneously, which will instruct the LMI to return to the preprogrammed limits.

**MESSAGE 1**

SET BOOM ANGLE  
LIMITS ?  
YES: PUSH REF #16  
NO : PUSH "E"

To confirm the intention to program boom angle preset limits press the "boom angle preset limit" button (16) and obtain the next Message.



To cancel the programming procedure for boom angle preset limits press the "E" button (18).

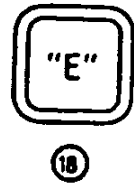

After pushing the button 'E' (18) the system returns to the operating mode and the display shows the actual values of max. load, act. load, radius, reeving condition and selected operating code.

**MESSAGE 2**

MAX. BOOM ANGLE  
LIMIT ?  
YES: PUSH REF #16  
NO : PUSH "E"

If a max. boom angle limit is desired (high boom angle) press the "boom angle preset limit" button (16) and obtain the next message.



To select a low boom angle limit only (low boom angle) press the "E" button (18) and obtain the message 5.

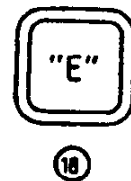

Message 3 and 4 are skipped by activating the "E" (18) button.

**MESSAGE 3**

```

MAX. ANGLE  80.0
ACT. ANGLE  41.2
CHANGE? YES:PUSH #16
           NO :PUSH "E"
  
```

The display shows the actual boom angle and the boom angle limit value programmed previously or preprogrammed.

To change the boom angle limit value press the "boom angle preset limit" button (16) and obtain the next message.

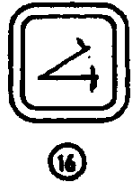

16

To keep the boom angle limit value unchanged press the "E" button (18) and carry on with message 5.

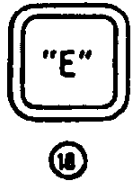

18

Message 4 is skipped by activating the "E" (18) button

**MESSAGE 4**

```

MAX. ANGLE  80.0
ACT. ANGLE  65.1
MOVE BOOM TO MAX
           TO SET PUSH "E"
  
```

The display informs the crane operator about current actual values and instructs him to move the boom to the maximum boom angle.

When the desired position is reached press the "E" button (18) to program the maximum boom angle limit and obtain message 5.

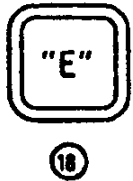

18

**MESSAGE 5**

MIN. BOOM ANGLE  
LIMIT ?  
YES: PUSH REF #16  
NO : PUSH "E"

If a minimum boom angle limit (low boom angle) is desired confirm by activating the "boom angle preset limit" button (16).



To keep the max. boom angle preset previously programmed and disregard the minimum boom angle preset press the "E" button (18) in order to return to the operational display.

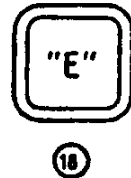

Message 6 and 7 are skipped by activating the "E" (18) button.

**MESSAGE 6**

MIN. ANGLE 10.0  
ACT. ANGLE 65.1  
CHANGE? YES: PUSH #16  
NO : PUSH "E"

The display shows the actual boom angle and the boom angle limit value programmed previously or preprogrammed.

To change the boom angle limit value press the "boom angle preset limit" button (16) and obtain the next message.



To keep the limit value unchanged press the "E" button (18) and carry on with message 8.

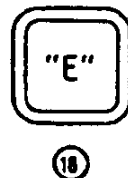

(After pushing button "E" (18), the system will skip over message 7)

**MESSAGE 7**

MIN. ANGLE	10.0
ACT. ANGLE	36.2
MOVE BOOM TO MIN	
TO SET PUSH "E"	

The actual boom angle information is displayed and the crane operator is instructed to move the boom to the minimum boom angle.

When the desired boom angle is reached press the "E" button (18) in order to program the minimum boom angle limit and obtain message 8.



18

**MESSAGE 8**

MAX. ANGLE	65.1°
MIN. ANGLE	36.2°

The previously programmed maximum and minimum boom angle presets are displayed for a few seconds.

**MESSAGE 9**

ANGLE	55.3°	■LIM.
LENGTH	137.4ft	■ 65°
HEIGHT	96.5ft	■ 36°
02 FALLS 00P.MOD0034		

*(Display will be in units corresponding to load capacity charts)*

The programming procedure is completed with Message 9. The LMI returns to the operational display indicating additionally the maximum and minimum boom angle presets programmed. The light in the button (16) will indicate the use of boom angle limits. Approaching boom angle limits will cause audible alarm and the button light (16) to flash.

**Warning**

<p>Exceeding a boom angle limit will not activate the lever lockout system. Therefore extreme caution is recommended when approaching a boom angle limit.</p>
---

## 5 Pre-Operation Inspection and Calibration Verification

Prior to operating the crane, the following electrical connections must be checked to ensure that the system is properly connected for the crane configuration.

### Machines with only a Main Hoist

If the crane works only with the boom and without boom extension or jib, no additional connections are necessary. However, be sure the weight of the anti-two-block switch is properly installed on the main hoist load line. With even parts of hoisting line, the weight shall be attached to the dead-end line. With odd parts of hoisting line, the weight shall be attached to the line of lowest speed.

If the crane works with boom extension or jib, the connecting cable shall be installed between the junction box on the boom extension or jib and the boom junction box. The weight attached to the main hoist anti-two-block switch shall be removed. In that case the anti-two-block switch has to be locked with the red Anti-Two-Block Retainer, which is fixed with a red lanyard at the anti-two-block switch (described on pages 39 and 40). Then the weight shall be reattached to the boom extension or jib anti-two-block switch.

### WARNING

**Failure to re-position the anti-two-block switch weight will prevent the overhoist system from functioning properly. No weight shall be on the main hoist anti-two-block switch when the boom extension or jib is being used.**

### Machines with Main and Auxiliary Hoists

If the boom extension or jib *is not* in the operating position, the by-pass plug shall be installed in the main boom junction box. The weight of the main hoist anti-two-block switch shall be installed.

If the boom extension or jib is in the operating position, the connecting cable shall be installed between the junction boxes on the boom extension or jib and the main boom. Weights shall also be attached to the anti-two-block switches on both the main boom and boom extension or jib.

If the boom extension or jib is in the operating position and no load line is being used on main boom, to prevent injury or damage to equipment, the weight shall be removed from main boom switch. In that case the anti-two-block switch has to be locked with the red Anti-Two-Block Retainer, which is fixed with a red lanyard (not shown) at the anti-two-block switch.

### Installation of Anti-Two-Block Retainer in Locking Position

Procedure (see Fig. 1 and 2):

1. Pull the cable out of the switch and bend back parallel to the boom and hold (1).
2. Slide the retainer from left side with it's slot over the cable between the crimped stop and the switch (2). Push it firmly straight onto the cable guide of the Anti-Two-Block switch (3).

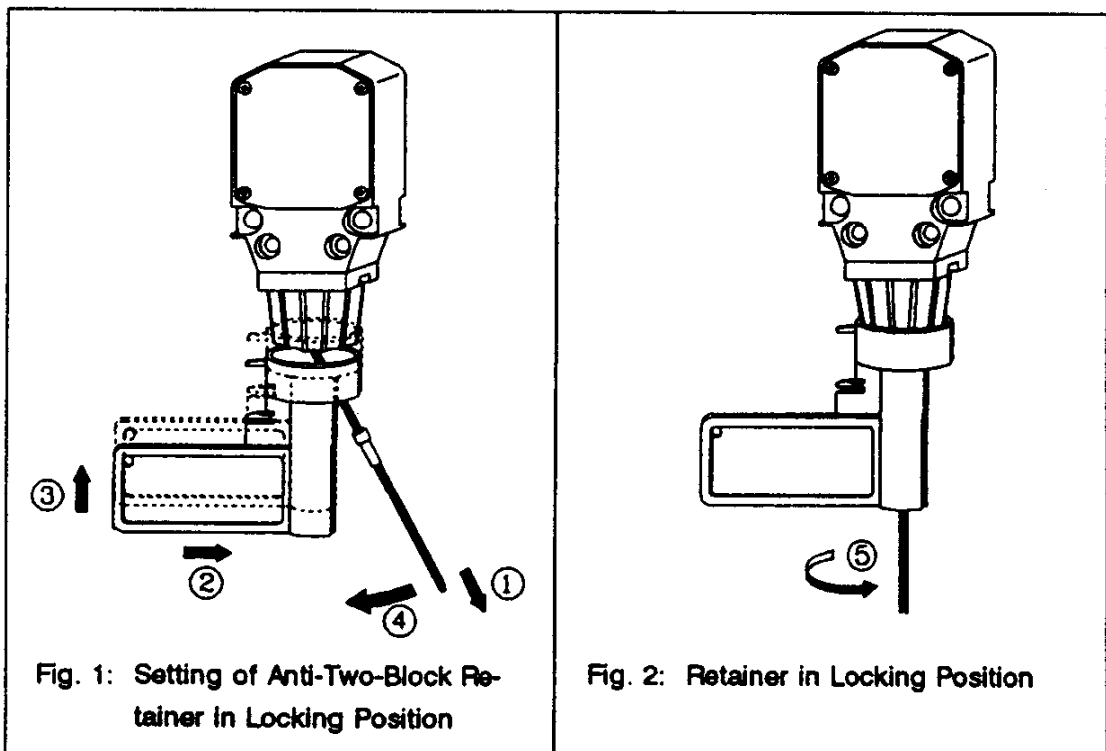

3. Straighten the cable completely into the slot and release the cable (4).
4. Turn the flag of the retainer for best visibility for the operator (5).

### Removal and Storage of the Anti-Two-Block Retainer

Procedure (see Fig. 3 and 4):

1. Pull the cable out of the switch (1) and bend back parallel to the boom and hold (2).
2. Move the retainer down (3) and then left (4) to remove it from the Anti-Two-Block switch. Release the cable.
3. For storage slide the retainer from right side (5) over the Anti-Two-Block switch until the clips (A) lock into the holes (B).

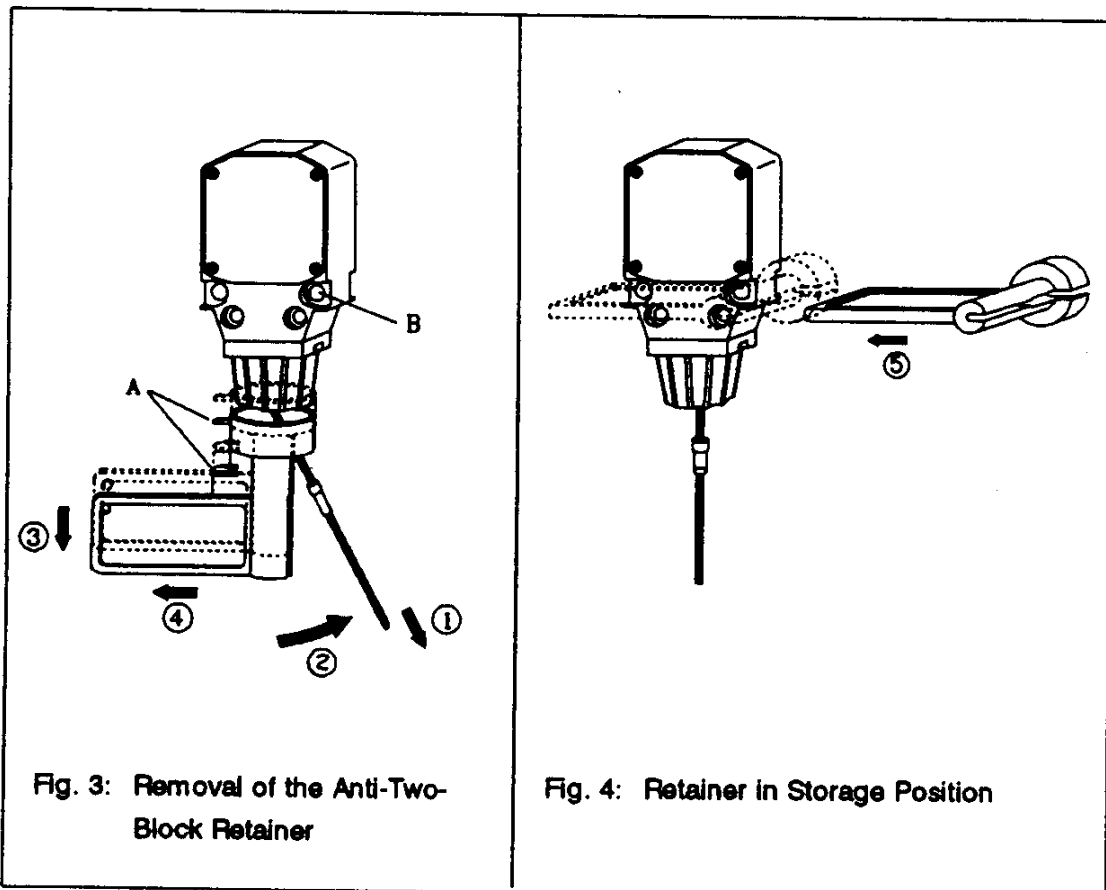



## Pre-Operation Inspection and Calibration Verification

After the electrical connections have been checked to insure that the system is properly connected for the crane configuration, the following checks shall be made:

1. Check the electrical wiring connecting the various parts of the system for physical damage.
2. Check the anti-two-block switches and weights for free movement.
3. Check the spring-loaded cable reel to be sure it is free to rotate, has tension and the cable is reeled properly.
4. Check mechanical installation and electrical connection of the force transducer(s) on jibs where applicable.

### WARNING

**The following tests shall be performed with care to prevent damage to the machine or injury to personnel. Proper functioning of the system requires successful completion of these tests before operating the machine.**

If the operator cannot see the load handling device approaching the boom nose, he shall have an assistant (signal person) watch the load handling device. The operator shall be prepared to stop the machine immediately should the LMI system not function properly as indicated by lighting the red warning light (8), sounding the audible alarm (23) and locking the crane movements, hoist up, telescope out and boom down.

Check the anti-two-block alarm light (8) and the audible alarm (23) by performing one of the following tests:

1. By manually lifting the weight attached to the anti-two-block switches. When the weight is lifted, the audible alarm (23) should sound, the anti-two-block alarm light (8) should light.

2. Slowly raise the main boom load handling device to create a potential two-block condition. When the load handling device lifts the weight, the audible alarm (23) should sound, the anti-two-block alarm light (8) should light and the motion of the load handling device should be stopped. Lower the load handling device slightly to eliminate this condition.
3. Slowly lower the boom to create a potential two-block condition. When the load handling device lifts the weight, the audible alarm (23) should sound, the anti-two-block alarm light (8) should light and the boom lowering function should be stopped. Lower the load handling device slightly to eliminate this condition.
4. Slowly extend (telescope) the boom to create a potential two-block condition. When the load handling device lifts the weight, the audible alarm (23) should sound, the anti-two-block alarm light (8) should light and the boom telescope out function should be stopped. Lower the load handling device slightly to eliminate this condition.

### **WARNING**

**If the light and audible alarm do not function as described and the crane movements are not stopped, the system is not working properly. The malfunction shall be corrected before operating the crane.**

5. If the crane is equipped with a boom extension or jib, repeat the test procedure for the boom extension or jib anti-two-block switch.
6. Check that the display of the main boom length agrees with the actual boom length.

7. Check that the display of the main boom angle agrees with the actual boom angles.
8. Check that the display of the operating radius of the crane agrees with the actual radius.
9. Check the load display by lifting a load of known weight. The accuracy of the load indication shall be within the tolerance of SAE J159.

## Operation

*After being properly programmed, the LMI is operational. Therefore, the operator shall be thoroughly familiar with all controls of the LMI and he shall properly set each switch before operating the crane. All settings shall be checked by lifting a load of known weight and comparing the load to the information displayed on the LMI.*

*Rated loads include the weight of the hook block, slings, and auxiliary load handling devices. Their combined weights shall be subtracted from the listed load capacities as stated on the load capacity chart to obtain the net load to be lifted.*

## WARNING

**If any of the displays reflect a deviation between displayed and actual values an authorized PAT service representative shall be called for repair of the system or reverification of the crane's LMI calibration.**

## WARNING

**Any structural modifications or changes to the crane shall require reverification of the crane's LMI calibration.**

## **6 SERVICE AND MAINTENANCE**

Daily maintenance of the load moment indicator consists of inspecting:

1. The electrical wiring connecting the various parts of the system. If electrical wiring is damaged, it shall be replaced immediately.
2. If the insulation is worn on the length sensor cable or cable guides are damaged, these parts shall be replaced.
3. Check the anti-two-block limit switches for freedom of movement.
4. The cable reel shall be under tension to operate properly.
5. Check the pressure transducers at the lift cylinder(s) and the connecting hoses for oil leakage.
6. Check mechanical installation and electrical connection of force transducer(s) on jibs where applicable.

Other than correcting the problems identified in the Malfunctions Table and replacing faulty mechanical parts and cables, no other repairs shall be performed by non expert personnel.

# 7 TROUBLESHOOTING

## General

In case of a malfunction of the system, the display (1) will indicate a code which identifies the system malfunction.

The error codes listed in the Malfunction Table will identify various faults which can occur with the LMI. Following the Malfunction Table are pages which explain each fault and describe the action which shall be taken to correct the fault.

Faults within the electronic microprocessor shall be repaired by factory trained service personnel. When these faults occur, the competent service organization shall be contacted.

## Malfunctions Table

Error Code	Error
E01	Fallen below the radius or above angle range
E02	Radius range exceeded or fallen below angle range
E03	Boom position is out of the permissible working area
E04	Operating mode not existing
E05	Prohibited length range
E06	Radius range exceeded or fallen below jib angle range

### NOTE:

*If there is any Error Code displayed on the console which is not listed in the Malfunctions Table you shall call the Local Distributor.*

## Operating Errors

Malfunctions in the system which are caused by range exceedings or operating errors by the crane operator himself are indicated on the display together with an explanation. These error codes are E01, E02, E03, E04, E05 and E06 and they can normally be eliminated by the crane operator himself.

### ERROR 01

E01: FALLEN BELOW  
RADIUS RANGE  
RADIUS = 27.4ft

E01: ABOVE ANGLE  
RANGE  
ANGLE = 80.0°

(Display will be in units corresponding to load capacity charts)

Cause:	Elimination:
Fallen below the minimum radius or above the angle given in the load capacity chart due to raising the boom too far.	Lower boom back to a radius or angle given in the load capacity chart.

**ERROR 02**

**E02: RADIUS RANGE  
EXCEEDED  
RADIUS = 75.6ft**

**E02: BELOW ANGLE  
RANGE  
ANGLE = 25.0°**

(Display will be in units corresponding to load capacity charts)

<b>Cause:</b>	<b>Elimination:</b>
The maximum radius or minimum angle given in the load capacity chart was exceeded due to lowering the boom too far.	Raise boom back to a radius or angle given in the load capacity chart.

**ERROR 03**

**E03: NO-LOAD AREA**

<b>Cause:</b>	<b>Elimination:</b>
Boom position is out of the permissible working area (over front).	Move boom back to the permissible working area. See lifting diagram in the load capacity charts.

**ERROR 04**

**E04: OPERATING MODE  
 NOT AVAILABLE  
 SEE LOAD CAPACITY  
 CHART \* PUSH "INFO"**

<b>Cause 1</b>	<b>Elimination</b>
Operating mode switch in the console set incorrectly.	Set operating mode switch correctly to the code assigned to the operating mode of the crane.
<b>Cause 2</b>	<b>Elimination:</b>
Operating mode is not permissible with the actual crane configuration, boom position or area definition.	Be sure crane is set up according to proper operating configurations.



**ERROR 05**

**E05: LENGTH RANGE  
 NOT PERMITTED  
 LENGTH = 75.3ft**

(Display will be in units corresponding to load capacity charts)

<b>Cause 1</b>	<b>Elimination</b>
<p>Boom was telescoped too far or not far enough, i.e. load curves for "on rubber", you may only operate up to a certain maximum or minimum boom length or with load curves for jibs where you have to telescope the main boom to a certain length.</p>	<p>Telescope boom to correct length, given in the load capacity chart.</p>
<b>Cause 2</b>	<b>Elimination</b>
<p>Length sensor adjustment changed i.e. length sensor cable slid off the length sensor drum.</p>	<p>For elimination refer to service manual.</p>

**ERROR 06**

**E06: BELOW JIB ANGLE  
RANGE  
JIB ANGLE = 15.0°**

**E06: RADIUS RANGE  
EXCEEDED  
RADIUS = 96.6ft**

(Display will be in units corresponding to load capacity charts)

<b>Cause</b>	<b>Elimination</b>
The minimum angle or the maximum radius of the luffing fly jib given in the load capacity chart was exceeded due to lowering the jib too far.	Raise jib back to an angle given in the load capacity chart.