

PRS 90

Multi-Sensor Display for PAT B5 Wireless Sensors



Operator's Manual

Issue A - 10/2015
Software v9

This document has the order no.
MAN-PS90-O-0001

Contents

Safety Instructions	1
Product Description	2
System Startup	3
System Settings (User)	4
Installation	5
Commissioning	6
Configuring the System	7
System Settings (Set-Up)	8
Operation	9
Service and Maintenance	10
Appendix	11

TABLE OF CONTENTS

1	Safety Instructions	7
1.1	EC Conformity Declaration	8
2	Product Description	8
2.1	General	8
2.2	Product Features	10
2.3	Base Console Kit	10
2.4	Product Identification	11
2.5	Overview of Functional Elements	12
2.6	Functional Elements	13
3	System Startup	14
3.1	Switching Device On and Off.....	14
3.2	Sensor Bar	16
3.3	CAN Heartbeat	16
3.4	Live Video (optional)	16
3.5	Configuring the System	17
3.5.1	Setting Rope Reeving	18
3.6	Limit Value Monitoring	19
3.6.1	Programming LIM for Wind Sensor	21
3.6.2	Programming LIM for Load Sensor.....	22
3.6.3	Programming LIM for Angle Sensor	23
4	System Settings (User)	25
4.1.1	LCD Brightness.....	26
4.1.2	Key Brightness.....	27
4.1.3	Digital Outputs	28
4.1.4	Set Units	30
5	Installation.....	31
5.1	Mounting the Components.....	31
5.1.1	vSCALE D2 Console	31
5.1.2	TRS 10-W2	32
5.1.3	Magnetic Base Antenna.....	34
5.2	Electrical Connection	35
5.2.1	Wiring of Console Connector.....	35
5.2.2	Wiring of vSCALE D2 Power Harness.....	36
5.2.3	Wiring of TRS 10-W2.....	36
5.2.4	Wiring of TRS 10-W2 Power Harness	37
5.2.5	Connecting the TRS 10-W2 Power Harness	37

6	Commissioning	38
6.1	Registering Wireless Sensors.....	39
6.1.1	Registering a Wind Sensor	42
6.1.2	Registering a Load Sensor	43
6.1.3	Registering a A2B Sensor	44
6.1.4	Registering an Angle Sensor	45
6.2	Deleting (Removing) Sensors.....	46
7	Configuring the System	47
7.1	Sensor Calibration	48
7.1.1	Calibrating Load Sensor	49
7.1.2	Calibrating Angle Sensor	50
7.2	Limit Output Signal Setup	51
7.2.1	Enabling Limit Output Signals for Angle Sensors.....	51
7.2.2	Enabling Limit Output Signals for Load Sensors	52
8	System Settings (Set-Up)	53
8.1.1	Sensor Information Transfer	54
8.1.2	Lock/Unlock System	55
9	Service and Maintenance	56
9.1	Uploading Software	57
10	Appendix	58
10.1	Technical Data	58
10.1.1	vSCALE D2.....	58
10.1.2	TRS 10-W2	58
10.1	Wiring Diagrams	60
10.1.1	System Layout	60
10.1.2	Wiring of vSCALE D2 Power Harness	62
10.1.3	Wiring of TRS 10-W2 Power Harness	64

VERSION OVERVIEW

Issue	Date	Description	Editor
A	8/2015	INITIAL RELEASE FOR SFT v8	AC

Introduction

Introduction

- About this Manual** This manual is a component of the equipment or systems supplied by Hirschmann Automation and Control GmbH. Keep this manual in a safe place and ensure that it is available to all users.
- Liability Disclaimer** The contents of this manual are subject to change. Hirschmann Automation and Control GmbH does not provide any guarantee for this material, including the associated guarantee regarding marketability and suitability for certain intended purposes. Hirschmann Automation and Control GmbH accepts no liability for errors in the contents of the manual or for direct or indirect damage in connection with the provision and use of the manual.
- Copyright Notice** This manual is protected by copyright. All rights reserved. The manual may not be duplicated, reproduced or translated into another language, either wholly or partly, without the prior written permission of Hirschmann Automation and Control GmbH.
- Trademarks** The rendition of common names, trade names, trademarks etc. in this documentation should not be construed to mean that such names, even without special identification, are free in the sense of trademark and trademark protection legislation and hence usable by anyone.
- Use for the Intended Purpose** This device/system is intended exclusively for the tasks described in this manual. Any other use shall be construed as being inappropriate. The manufacturer accepts no liability for damage caused by inappropriate or impermissible use. This device / system may only be used if it is in perfect technical condition.
- Qualification of the Operating Personnel** Only appropriately qualified personnel may work with this device / system, i.e. persons:
- who are familiar with the operation or installation and commissioning
 - who know the current regulations for the prevention of accidents

Marking of Notices

Dangers and other important notices are marked as follows in this user manual:



WARNING

Warning of direct threat of personal injury and damage to property.

Instructions on precautions to avert the danger.



CAUTION

Warning of dangerous situations. Also warns of damage to property.

Instructions for averting the danger.

IMPORTANT

Warning of possibly damaging situation for the product.

Instructions for avoiding the possibly damaging situation.



NOTE

Usage instructions and information, but no dangerous situation.



HINT

Supplementary comments and recommendations for the user.

1 Safety Instructions

In order to avoid possible person injuries and damage to property when using this device, it is essential to observe the following safety instructions.



CAUTION

The PRS 90 is an aid for displaying measured values, which are measured by various wireless sensors and transmitted wirelessly to the central device.

Although functions are integrated in the system for monitoring adjustable limit values with visual and acoustic warnings as well as a digital output when limit values are exceeded, the system may not be used as a safety device in the sense of EN 954 or EN 13849.

The relay output may not be used as an operation limit switch for the monitoring of limits values.

The system cannot and also should not be a replacement for the good judgment or experience of the operator or the use of safe working methods when using loading machines or other technical equipment.

The operator is responsible for the safe operation of the loading machine or other technical equipment. He must ensure that he understands and observes the information and instructions in their entirety.



CAUTION

The device is used together with wireless load sensors in lifting equipment with a multiple reeved lifting rope, then it is of fundamental importance for a correct load display and for the limit value monitoring to correctly input the number of rope reevings according to the actual number of rope reevings.

Therefore, the necessary inputs may only be made by operators who are familiar with the operation of the system.

IMPORTANT

Connection to the wrong power supply will cause damage to the device.

The device may only be connected to a DC voltage source of 10 V to 30 V!

1.1 EC Conformity Declaration



The technical design and construction of the **vSCALE D2** console corresponds to requirements of the EMC directive 2004/108/EC and therefore carries the CE symbol.

The device complies with the following harmonized standards:
EN 12895:200, EN 13309:2010, EN ISO 14982: 2009

The full conformity declaration is available from the manufacturer on request.

2 Product Description

2.1 General

The PRS 90 is an aid for displaying measured values, which are measured by various wireless sensors and transmitted wirelessly to the central device.

Although functions are integrated in the system for monitoring adjustable limit values with visual and acoustic warnings as well as a relay output when limit values are exceeded, the system may not be used as a safety device in the sense of EN 954 or EN 13849.

The **vSCALE D2** console is the operable component and display of the PRS 90, referred to below as the indicator system. The **vSCALE D2** is the control for the wireless sensors from the **xSENS-W1** family. The sensors are connected by a radio link in the 2.4 GHz ISM band and may be operated license-free worldwide. In order to be able to use the device, at least one wireless sensor is necessary.





Which Sensors Can Be Used?

From the extensive range of Hirschmann wireless sensors, all sensors from the **xSENS-W1** family can be used, see Table 1: Compatible Sensors.

How Many Sensors Can Be Connected?

A total of up to 8 sensors can be connected wirelessly.

Table 1: Compatible Sensors
xSENS-W1 Wireless Sensors

Application	Product Designation	Kit Number (includes mounting hardware)	Picture
Load Measurement	fSENS KMD-W1 (15k)	102028	
	fSENS KMD-W1 (45k)	102029	
Angle Measurement	gSENS WGF-W1 (0 to 90°)	102031	
Wind Measurement	iSENS WSS-W1	102032	
Anti-Two Block (A2B) Switch	iSENS HES-W1	102030	

2.2 Product Features

Features:

- Easily and clearly shows operator required information
- Wireless operation
- Can display in multiple units (Domestic (lbs.), Domestic (kips), and Metric (SI))
- Load display: Display of current load & reeving
- Angle display: Display of current boom angle
- Wind display: Display of current wind speed
- A2B display: Display of monitoring OK or two-blocked
- Multiple limits can be set
- Acoustic alarm on reaching a set limit value
- Monitoring and display of connection status of connected sensors
- Digital Output for exceeding set limit values and for two-blocked A2B switches
- Protection class IP 66/67
- Operating temperature range of -40°C to +75°C (-40°C to +85°C storage)
- Voltage supply 10 to 30 V DC
- CAN heartbeat monitoring

2.3 Base Console Kit

The console kit (HUS PN 102050) includes:

- **vSCALE D2** operating console
- **TRS 10-W2** 2.4GHz wireless receiver
- vSCALE D2 **power harness**
- TRS 10-W2 **power harness**
- vSCALE D2 mounting equipment
- Magnetic base antenna with 4m connecting cable

Sensors required for PRS 90 operation purchased separately (see Table 1: Compatible Sensors).

2.4 Product Identification

The type plate carries the unique identification of the operating console with PRS90 software installed. It is located on the left side of the console, and should have the P/N: 061093.

Please ensure you make a note of all the information on your type plate for queries about this product.

Type Plate Example

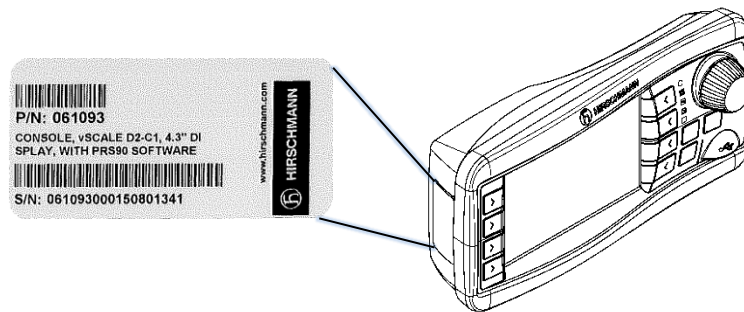

Figure 1: Type Plate Example

2.5 Overview of Functional Elements

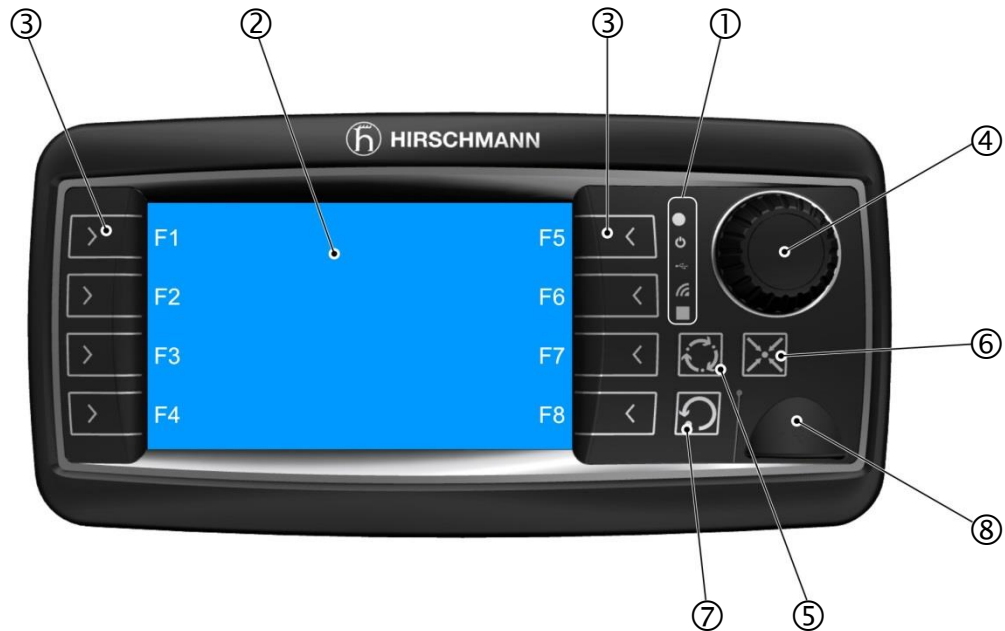
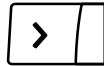

Figure 2: Functional Elements of vSCALE D2 Console

Legend

- 1 Ambient light sensor / Status LEDs
- 2 TFT color display 4.3 inch
- 3 Function keys **F1 – F8**
- 4 Rotary control (encoder) with pushbutton function
- 5 **Set** key for silencing alarms and confirming system settings
- 6 **Home** key for return to main menu
- 7 **Esc** key for return to previous menus or previous setup-ups
- 8 USB 2.0 interface (only for service purposes)

2.6 Functional Elements



Function Keys F1 to F8 Calls Functions



Light Sensor: Not Used



Operating Display: Green While Supply Voltage is Connected



USB Data Display: Yellow During Data Exchange via Front USB Port



Multi-Function Light: Not Used



Wireless Indicator: Not Used

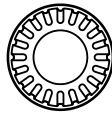

Encoder With Pushbutton Function: For Selection and Confirmation When Making Inputs



SET key: Selects Settings / Silences Alarm



HOME key: Returns to Main Working Screen



ESCAPE key: Returns to Previous Menu / Aborts Function

User Portion

3 System Startup

At least one wireless sensor must be available in order to commission and operate the system. A guide to commissioning the PRS 90 and the wireless sensors can be found in [Section 6](#).

3.1 Switching Device On and Off

The PRS 90 is switched on or off by connecting or disconnecting the power supply.

After switching on, the acoustic alarm sounds briefly and the system begins with a self-diagnosis routine.

After boot-up, the Main Working Screen appears on the display. The main working screen has 3 screens. The first screen displays sensors 1-4 and is automatically displayed upon startup. Turn the rotary knob counter-clockwise to scroll down to pages 2 and 3.

The sensor bar will in all screens excluding the camera screen (see [Section 3.2](#)).

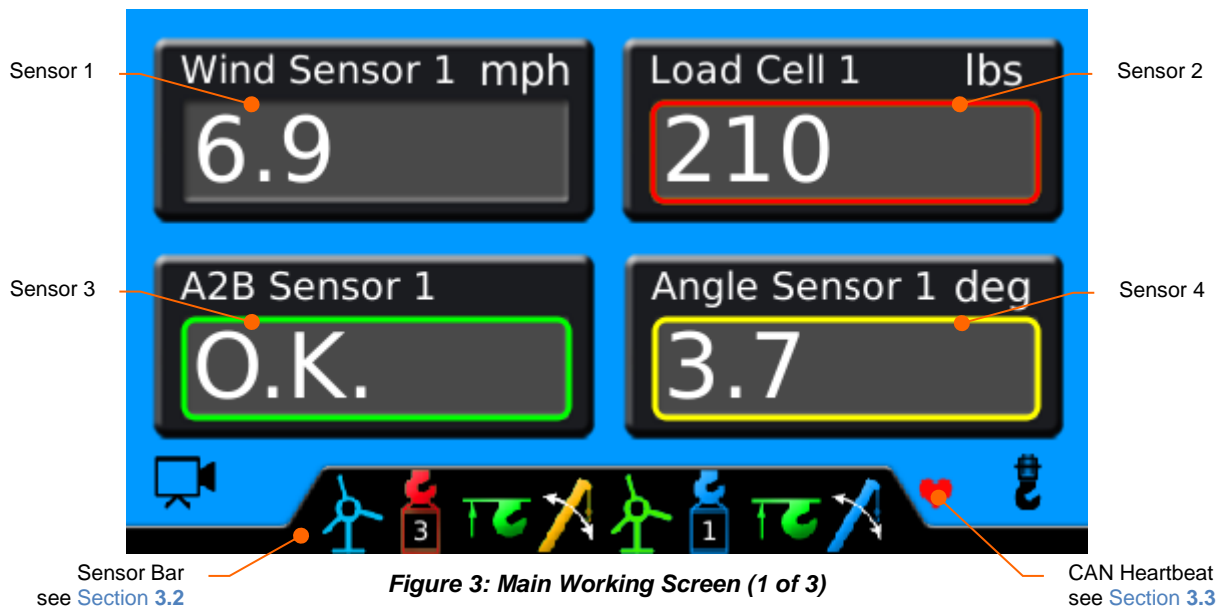

User Portion
System Startup

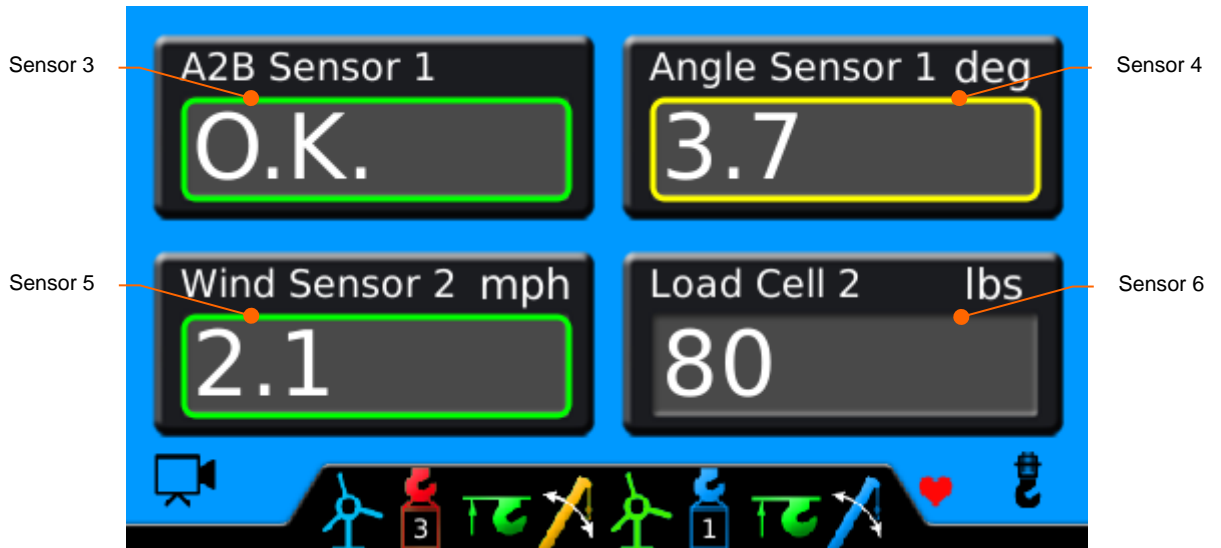

Figure 4: Main Working Screen (2 of 3)

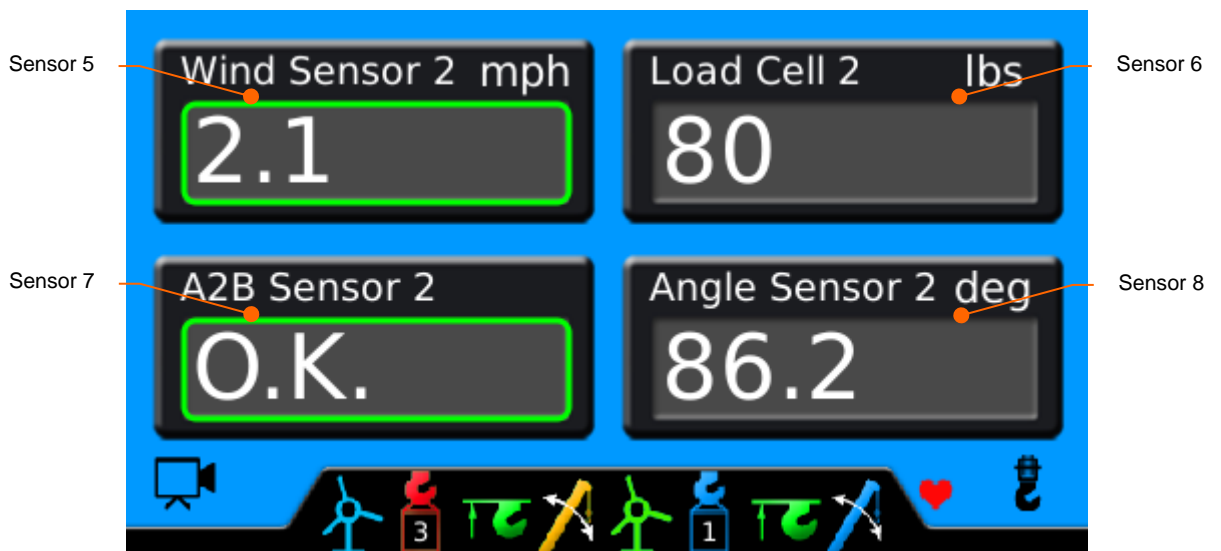

Figure 5: Main Working Screen (3 of 3)

3.2 Sensor Bar

The sensor bar will display in all screens, excluding the camera screen. The sensor bar displays the state of active sensors.

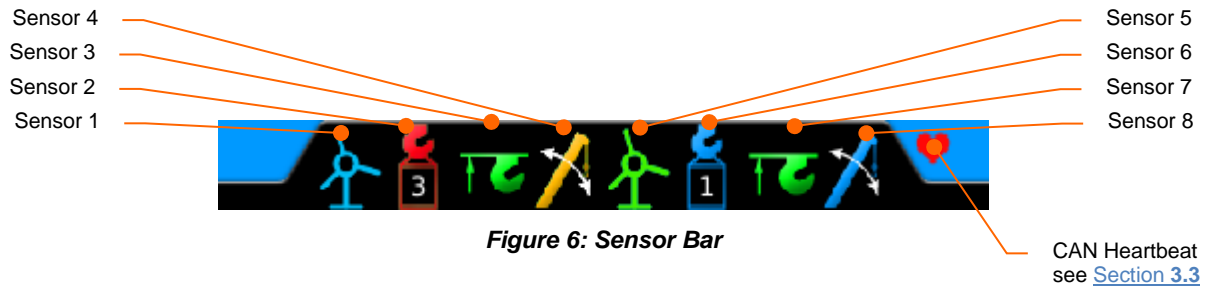

States monitored and displayed include:

- If a limit has been set (wind, load, and angle)
 - If set, the state of the limit
- A2B status
- Reeving of load cell
- CAN Heartbeat Status



3.3 CAN Heartbeat

The CAN Heartbeat is monitored and displayed in all screens, excluding the camera screen. The CAN heartbeat transmits every 250ms. If one heartbeat is missed, an audible alarm will sound and the CAN Heartbeat icon in the sensor bar will flash on and off.

	CAN OK
 flashing	CAN Not OK



3.4 Live Video (optional)

You can (optionally) show the live video image on the display. Pressing F4 from the Main Working Screen will call up the Live Video.

3.5 Configuring the System

If the system is used together with wireless load sensors, the rope reeving must be set (see [Section 3.5.1](#)). The sensor must also be calibrated (see [Section 7.1.1](#)).



CAUTION

The device is used together with wireless load sensors in lifting equipment with a multiple reeved lifting rope, then it is of fundamental importance for a correct load display and for the limit value monitoring to correctly input the number of rope reevings according to the actual number of rope reevings.

Therefore, the necessary inputs may only be made by operators who are familiar with the operation of the system.

If the system is used together with wireless angle sensors, the zero point of the angle sensor must be adjusted after mounting (see [Section 7.1.2](#)).



3.5.1 Setting Rope Reeving

Setting the rope reeving is only necessary and possible when using active load sensors. The rope reeving can be set by pressing F8 on the Main Working screen. This will call up the Load Reeving screen.

Rope Reeving
Screen Example



Figure 7: Load Reeving Screen (example)

Press the corresponding function button to increase the reeving by 1 (until 25, when it then cycles to 1). When the reeving is changed, the corresponding sensor icon button in the sensor bar will show the number of reeving.



3.6 Limit Value Monitoring

The system features a 'limit value monitoring' function with programmable limit values. The functions can be set individually or in combination. Press F5 from the Add/Delete/Calibrate/LIM Screen to call up the Limit screen.

LIM Screen Example



Figure 8: LIM Screen (example)

What Limits Can Be Set?



Program Limit for Wind Sensor (see [Section 3.6.1](#))



Program Limit for Load Sensor (see [Section 3.6.2](#))



Program Limit for Angle Sensor (see [Section 3.6.3](#))

Limits for A2B are not able to be set.

Saving Values

If limit values are set, they will be stored after the system is switched off. The limits will remain active if the system goes through a power cycle.









NOTE

Limit Output Signals can be enabled for load and angle sensors. See [Section 7.2](#).
Relays will need to be added for Limit Output Signals! DOs 1-3 supply ground.

Warnings and Alarms

Active limit values are indicated by the display of color-highlighted symbols. The icons in the sensor bar and the sensor values on the main screen will change color.

Icons	Color	Description
	Blue	Limits Not Activated
	Green	Limit Activated and Within Set Limit
	Yellow	Limit Nearing Set Limit
	Red	Limit Exceeded Audible alarm will sound If Limit Output Signal Functionality is enabled the Digital Output will go low (see Section 4.1.3)
	Green	A2B OK
	Red	A2B Not OK Audible alarm will sound Digital Output 1

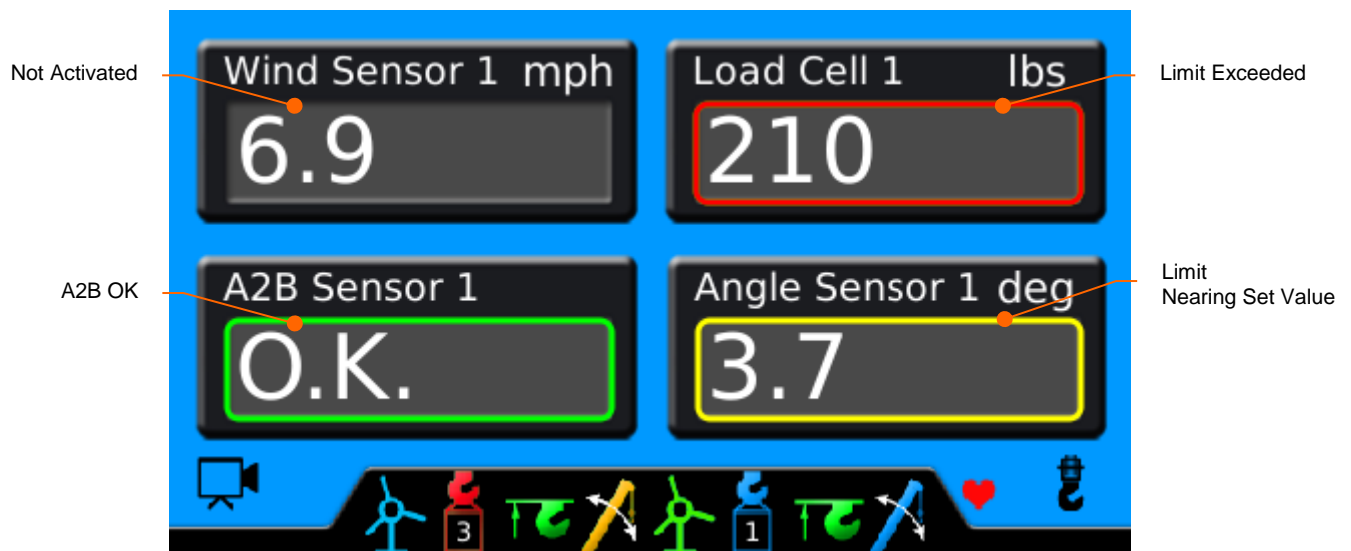

Figure 9: Main Working Screen with Activated Limits (example)



3.6.1 Programming LIM for Wind Sensor

Press the corresponding function button from the LIM screen to set the limit. This will call up the Wind Sensor Limit Screen



Figure 10: Set Wind Sensor Limit Screen

Wind Sensor Limits are set by the following instructions:

Instructions



- Turn the rotary knob to change the highlighted digit to the desired number.
 - Limit value will increment/decrement by 1 unit
- Press F3 to set & activate / deactivate limit
 - Wind Sensor icon in sensor bar will change color
 - Set Limit Button  (F3) will change color



3.6.2 Programming LIM for Load Sensor

Press the corresponding function button from the LIM screen to set the limit. . This will call up the Load Sensor Limit Screen.

Enable/Disable
Limit Output Signal
See [Section 7.2.2](#)

Limit Value

Current
Value

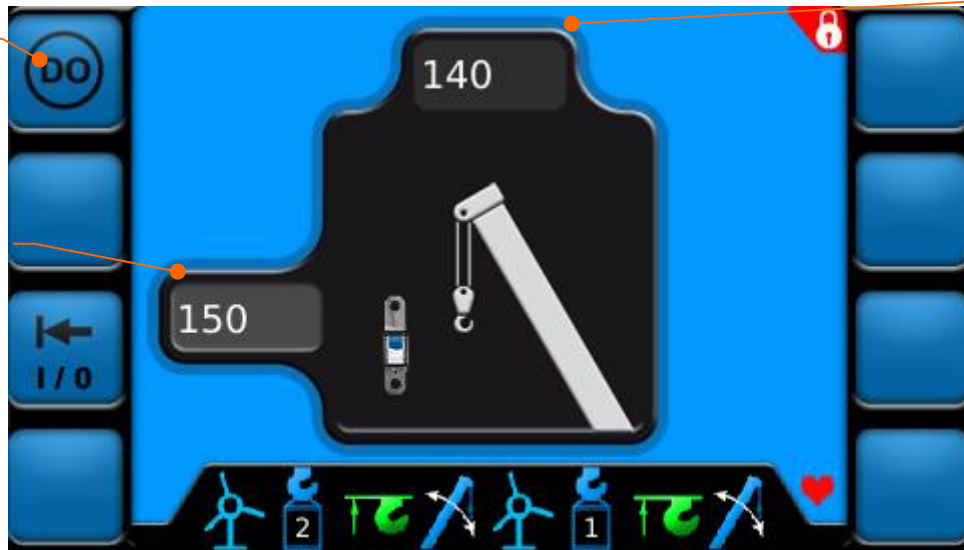



Figure 11: Set Load Sensor Limit Screen

Load Sensor Limits are set by the following instructions:

Instructions



- Turn the rotary knob to change the highlighted digit to the desired number
 - Limit Value will increment/decrement by 50 units x reeving multiplier
 - Example: If load sensor has a reeving of 2, the limit value will increment by 100 (50*2=100)
- Press F3 to set & activate / deactivate limit
 - Load Sensor icon in sensor bar will change color
 - Set Limit Button  (F3) will change color



3.6.3 Programming LIM for Angle Sensor

Press the corresponding function button from the LIM screen to set the limit. . This will call up the Angle Sensor Limit Screen.

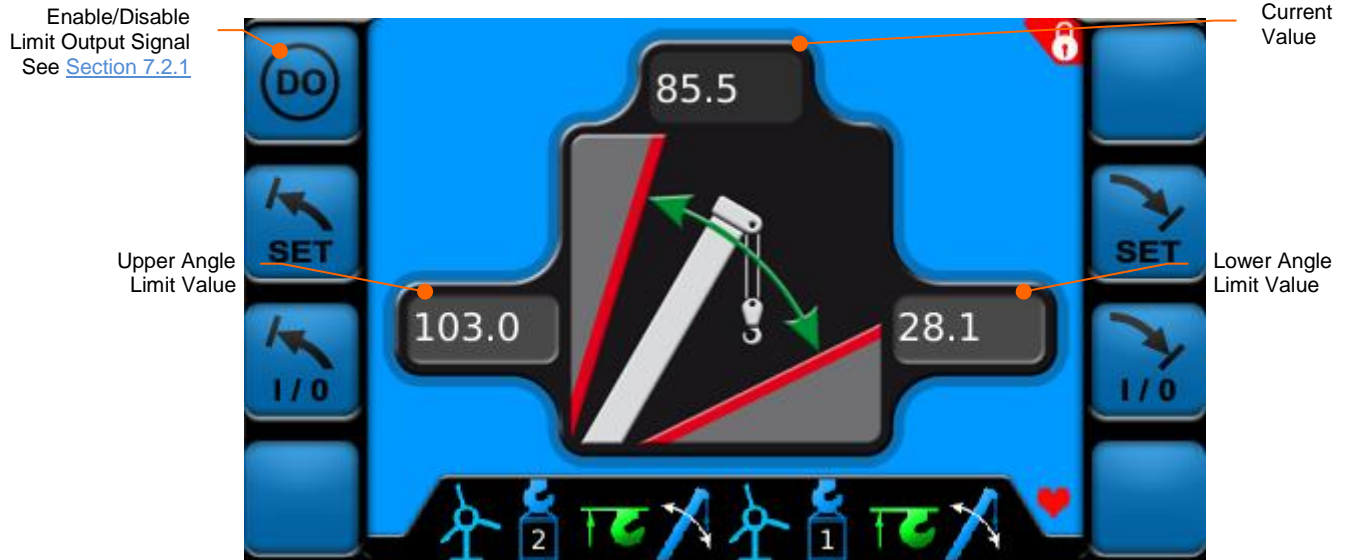



Figure 12: Set Angle Sensor Limit Screen

Instructions Upper Limit



The upper angle limits for Angle Sensors are set by the following instructions:

- Boom up to desired maximum angle value (current value is displayed at top of screen)
- Press the Set Upper Limit Button  (F2) to set the upper value as the current angle value (this will change the upper limit value)
- Press F3 to activate/deactivate upper limit
 - Upper Limit I / O Button  (F3) will change color

User Portion
System Startup

Instructions The lower angle limits for Angle Sensors are set by the following instructions:

Lower Limit

- Boom up to desired maximum angle value (current value is displayed at top of screen)
- Press the Set Upper Limit Button  (F2) to set the upper value as the current angle value (this will change the upper limit value)
- Press F3 to activate/deactivate upper limit
 - Upper Limit I / O Button  (F3) will change color

4 System Settings (User)

The Setup menu allows the user to configure various settings and view Digital Output statuses. Pressing F8 from the Sensor Add/Delete/Calibrate/LIM Screen will call up the Sensor Calibration screen.

Software Version



Figure 13: Setup Screen

Function
Keys



LCD Brightness
(see [Section 4.1.1](#))



Sensor Information Transfer 
(see [Section 8.1.1](#))



Key Brightness
(see [Section 4.1.2](#))



Set Units
(see [Section 4.1.4](#))



Digital Outputs
(see [Section 4.1.3](#))



Lock/Unlock System 
(see [Section 8.1.2](#))



NOTE

The symbol  indicates that the screen is password protected. If the system is not unlocked, pressing password protect function buttons will have no function.

See [Section 8.1.2](#) for more information on unlocking the system.

User Portion
System Settings (User)



4.1.1 LCD Brightness

The brightness of the LCD screen is able to be adjusted from 5% to 100%. Pressing F1 from the Setup Screen will call up the LCD Brightness Screen.

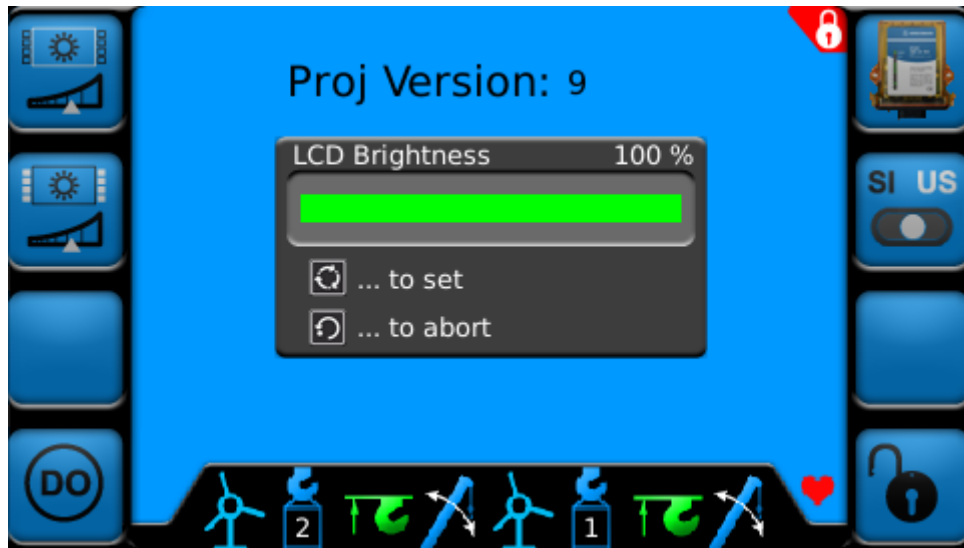



Figure 14: LCD Brightness Screen

LCD Brightness is set by the following instructions:

Instructions



- Turn the rotary knob to change the LCD Brightness between 5% and 100%
- Once the desired brightness is selected, press the SET  key to set.
- To abort, press the ESCAPE  key



4.1.2 Key Brightness

The brightness of the function keys is able to be adjusted from 5% to 100%. Pressing F2 from the Setup Screen will call up the Key Brightness Screen.





Figure 15: Key Brightness Screen

LCD Brightness is set by the following instructions:

Instructions



- Turn the rotary knob to change the LCD Brightness between 5% and 100%
- Once the desired brightness is selected, press the SET  key to set.
- To abort, press the ESCAPE  key



4.1.3 Digital Outputs

The system has three digital outputs. Pressing F4 from the Setup Screen will call up the Digital Output Screen.



Figure 16: Digital Output Screen

Limit output signals can be enabled when user set limits are exceeded for angle or load sensors. Limit output signal functionality cannot be disabled for A2B sensors. This function can be set for individual sensors or in combination. See [Section 7.2](#) for enabling limit output signals [Section 3.6](#) for setting user limits.

In order for a digital output to change state, the limit output signal must be activated **and** limits must be set. When both of these conditions are met, an audible alarm will sound, the corresponding digital output will go low, and the digital output display will turn red.

Description of DOs

Digital Output	High (default)	Low (activated)
1	<ul style="list-style-type: none"> • Default • A2B OK • Load limit output signal activated and under set limit 	<ul style="list-style-type: none"> • ATB Error • Load limit output signal activated and exceeded limit
2	<ul style="list-style-type: none"> • Default • Angle lower limit activated and above set limit 	<ul style="list-style-type: none"> • Angle lower limit activated and exceeded limit
3	<ul style="list-style-type: none"> • Default • Angle upper limit activated and below set limit 	<ul style="list-style-type: none"> • Angle upper limit activated and exceeded limit

User Portion
System Settings (User)

Example



Figure 17: Digital Output Screen with DO1 Low



NOTE



Relays will need to be added for Limit Output Signals! DOs 1-3 supply ground.

User Portion
 System Settings (User)

4.1.4 Set Units

The units can be set in the Setup Screen by pressing F6. Every time F6 is pressed, the units will change. This is indicated visually by the button in the setup screen and the units in the main working screen changing.

 Description Unit
 Buttons

Icon	Actual Units		
	<i>Wind</i>	kilometers per hour	kph
	<i>Load</i>	metric ton	t
	<i>Wind</i>	miles per hour	mph
	<i>Load</i>	short ton	ton
	<i>Wind</i>	miles per hour	mph
	<i>Load</i>	pounds	lbs

Set-Up Portion

5 Installation

5.1 Mounting the Components

The equipment is supplied complete with necessary mounting parts. For mounting the wireless sensors, please refer to the instructions provided with the respective sensor.



NOTE

PLEASE RECORD SENSOR ID INFORMATION PRIOR TO INSTALLING YOUR SENSORS

See [Section 6.1](#) for more detail.

5.1.1 vSCALE D2 Console

The **vSCALE D2 Console** is mounted using a ram mount and ram mount adapter (see Figure 18: Mounting the Console for visual detail). The recommended mounting method is as follows:

1. Attach the Ram Mount Adapter to the back of the console
2. Plug the vSCALE D2 power harness into the console
3. Attach one end the Ram Mount to the back of the console
4. Attach the opposite end of the Ram Mount to the cab

Set-Up Portion
Installation

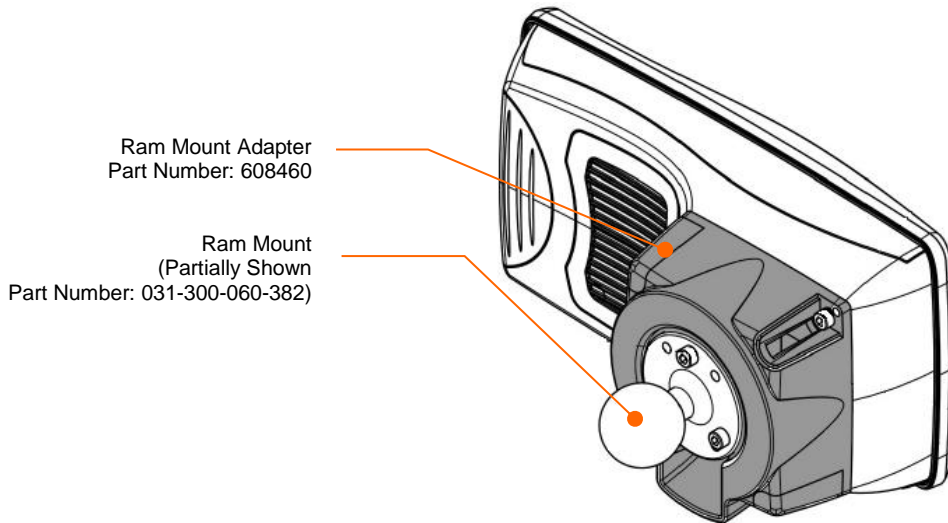

Figure 18: Mounting the Console

5.1.2 TRS 10-W2

The **TRS 10-W2** must be mounted in a suitable place on a sufficiently firm surface with the connectors at the bottom. The device may be used both indoors and outdoors, but must be mounted such that the LEDs are visible. For more information on the **TRS10-W2**, please refer to the **TRS10-W2** manual.

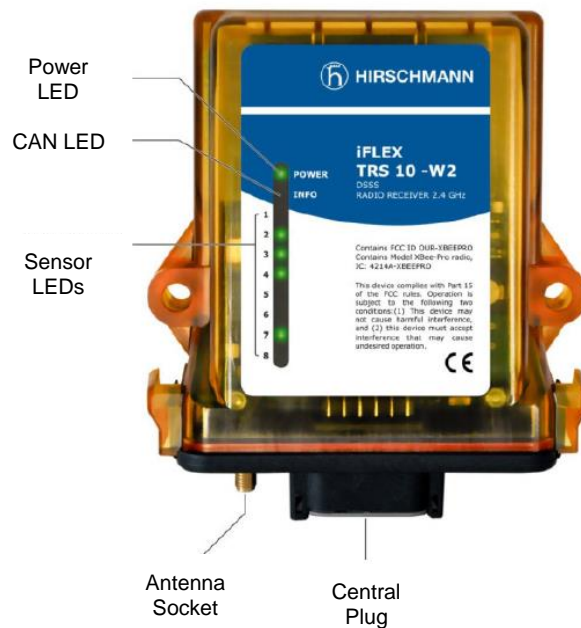

Figure 19: TRS 10-W2

Set-Up Portion
Installation

The distance between the holes in the housing is 102mm.

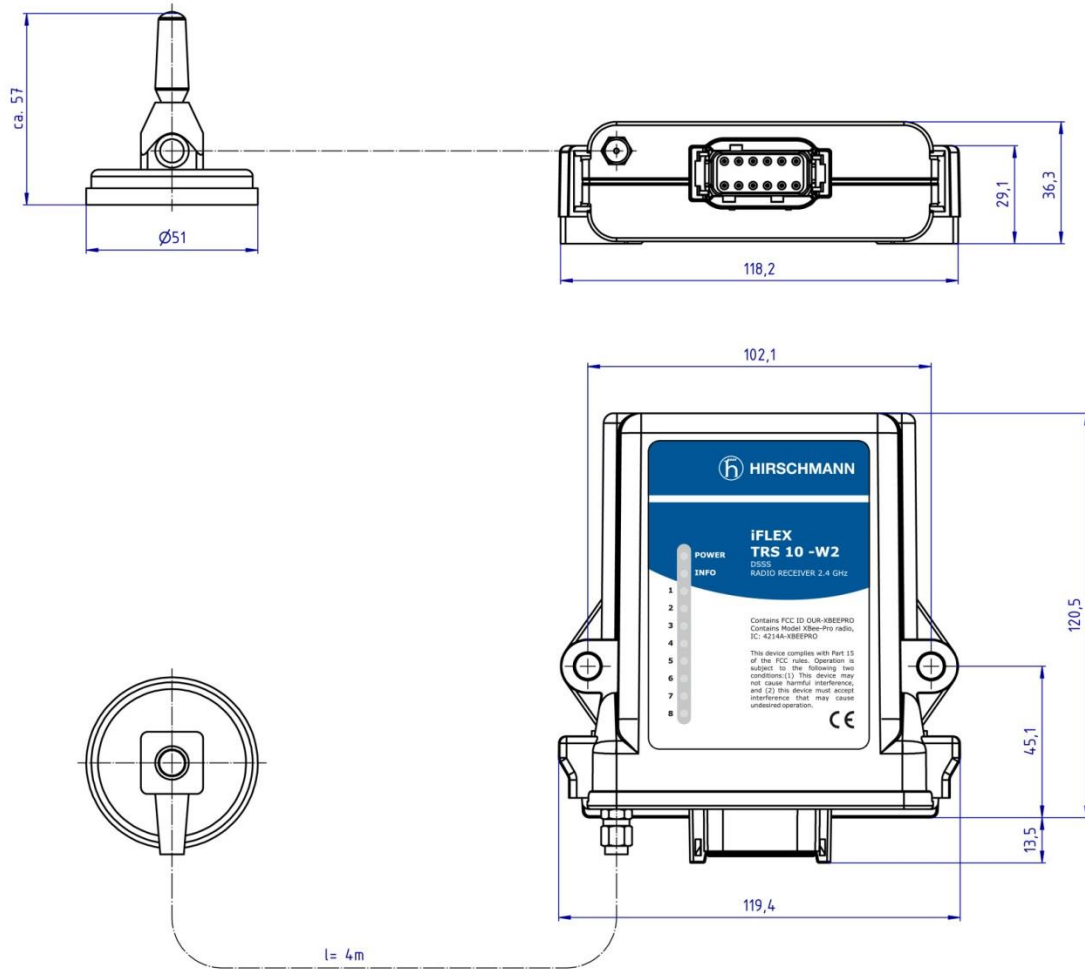

Figure 20: Dimensions of TRS10-W2

5.1.3 Magnetic Base Antenna

The antenna radiator must first be screwed hand tight onto the thread on the top side of the antenna space until a soft stop is felt.

The antenna has a magnetic baseplate and adheres securely to all ferromagnetic surfaces.

Lay the antenna cable in such a way that it is neither squeezed nor laid upon sharp edges. Doing so can cause the cable to be damaged

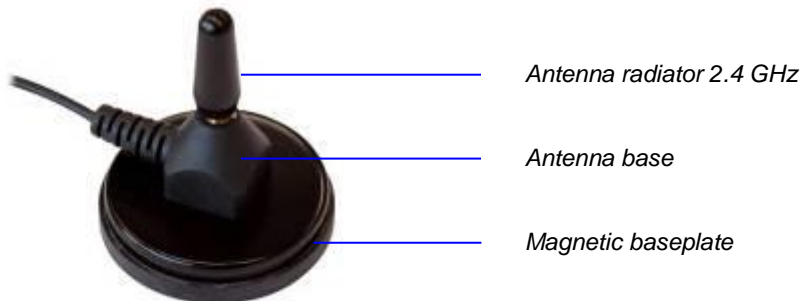

Figure 21: Magnetic Base Antenna



NOTE

Optimal ranges are achieved if the antenna is in horizontal alignment with the wireless sensor antennas.

After laying the antenna cable, connect the coaxial connector of the antenna to the antenna socket on the underside of the **TRS 10-W2**. Screw the connector on hand tight.

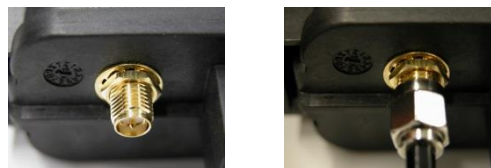

Figure 22: Connecting Antenna to TRS10-W2

IMPORTANT

The function of the antenna (and thus the whole system) can be impaired if a mismatching antenna radiator is used.

Always use the antenna radiator contained in the console kit (HUS PN 102050).

5.2 Electrical Connection

Connection to power is done through the vSCALE D2 power harness. The open end of the cable is to be connected properly using wire and ferrules.

5.2.1 Wiring of Console Connector

Please refer to the following illustration for the pin configuration of the console, located on the back of the vSCALE D2.

Connector View

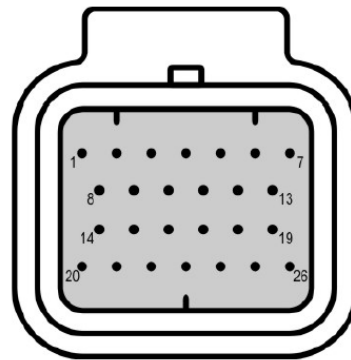

Figure 23: vSCALE D2 Pinout

Pin Assignment

Pin	Description	Pin	Description
1	Vcc +9...36 V DC	14	USB D-
2	Ignition	15	USB D+
3	GND	16	RS232 RxD
4	Car GND	17	RS232 TxD
5	n.c	18	RS232 GND
6	n.c.	19	AI/DI 3
7	n.c.	20	AI/DI 1
8	CAN 1 High	21	AI/DI 2
9	CAN 1 Low	22	AI/DI 4
10	CAN 2 High	23	SERV_ENABLE
11	CAN 2 Low	24	DO3
12	USB Vcc (+5V)	25	DO 1
13	USB GND	26	DO2

Set-Up Portion
 Installation

5.2.2 Wiring of vSCALE D2 Power Harness

Please refer to [Section 10.1.2](#).

5.2.3 Wiring of TRS 10-W2

Please refer to the following illustration for the pin configuration of the wireless receiver, located on the bottom of the **TRS10-W2**.

Connector View

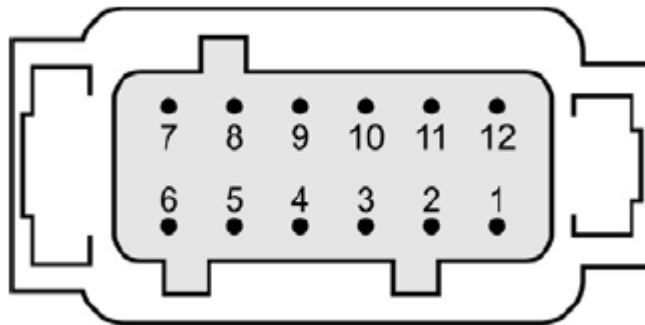

Figure 24: TRS10-W2 Pinout

Pin Assignment

Pin	Description	Pin	Description
1	V DC (10-30V)	7	n.c.
2	GND	8	n.c.
3	KGND (ground)	9	n.c.
4	n.c.	10	n.c.
5	KGND (shield)	11	CAN 1 High
6	n.c.	12	CAN 1 Low

Set-Up Portion
Installation

5.2.4 Wiring of TRS 10-W2 Power Harness

Refer to [Section 10.1.3](#).

5.2.5 Connecting the TRS 10-W2 Power Harness

Insert the central plug of the cable until it clicks, and then push the boot completely over the connector:

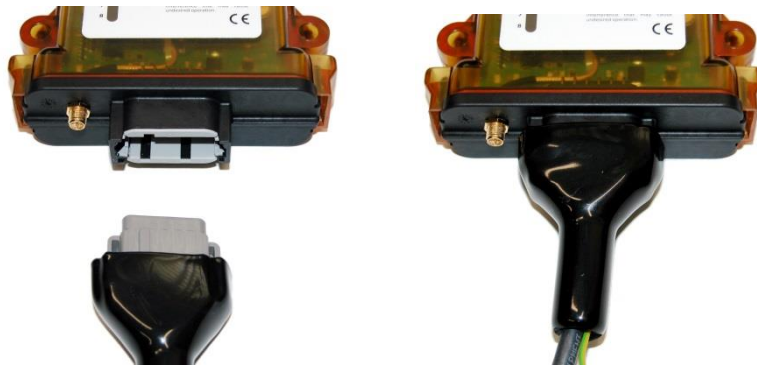

Figure 25: Connecting TRS10-W2 Power Harness

To comply with the EMC requirements for the surge voltages of power supply lines (EN 61000-4-5), it is necessary that the ground wire is conductively connected to the vehicle chassis when mounting the iFLEX TRS10-W2. Refer to the TRS10-W2 manual for more detail.



Figure 26: Connecting TRS10-W2 Power Harness for EMC Compliance

6 Commissioning

At least one wireless sensor must be available in order to commission and operate the system. You will find a guide to commissioning the PRS 90 and the wireless sensors below.

After boot-up, the Main Working Screen appears on the display:

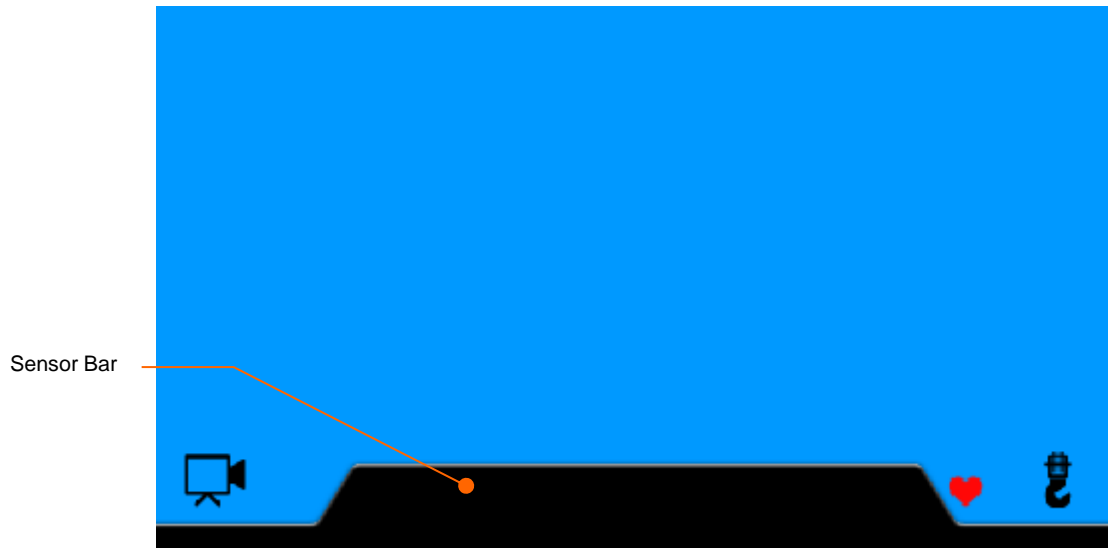

Figure 27: Main Working Screen (no sensors installed)

The main working screen has 3 screens. The first screen displays sensors 1-4 and is automatically displayed upon startup. Turn the rotary knob counter-clockwise to scroll down to pages 2 and 3.

The sensor bar will display the active sensors in all screens (excluding the camera screen). See [Section 3.1](#) for examples of the Main Working Screen with sensors installed.

6.1 Registering Wireless Sensors

Every wireless sensor to be used must be registered once on the central device. Wireless sensors that are no longer to be used must be deleted from the list of installed sensors (see [Section 6.2](#)).



NOTE

THE FOLLOWING INFORMATION WILL BE NEEDED TO REGISTER SENSORS PRIOR TO INSTALLATION.

PLEASE COMPLETE THIS STEP BEFORE INSTALLING YOUR SENSORS

Before registering any sensor, the following must be done:

- Open the battery compartment
- Remove the batteries
- Make note of the Node ID
 - The Node ID is a 5 digit number
 - The Node ID is located above the software version number (see Figure 28: Node ID)
- Install batteries
- Close and secure the battery compartment
- Use [Sections 6.1.1](#), [6.1.2](#), [6.1.3](#), and [6.1.4](#) to register sensors

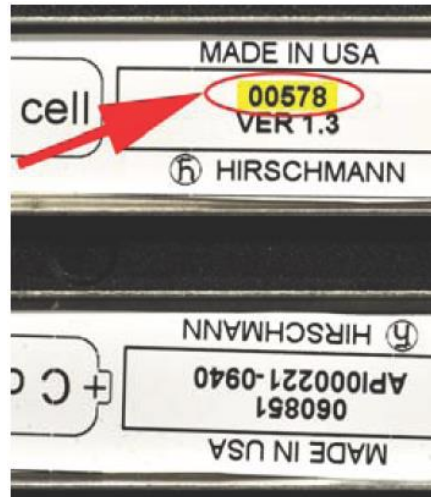

Figure 28: Node ID

Set-Up Portion
 Commissioning

Sensor #	Sensor Type	Sensor ID
1		
2		
3		
4		
5		
6		
7		
8		

Example:

1	<i>Wind</i>	00578
----------	--------------------	--------------

NOTE

When a sensor is added, it is added to the first available sensor spot (1-8). The sensor will not change spots unless the sensor is deleted and re-added.

NOTE

Follow the mounting and adjustment instructions included with each sensor.



Set-Up Portion
Commissioning



Press F1, F2, F3, F5, F6, or F7 to call up the Sensor Add/Delete/Calibrate/LIM Screen. See [Section 2.5](#) for more detail on Function Buttons.







Figure 29: Sensor Add/Delete/Calibrate/LIM Screen

Function
Keys



 Add Wind Sensor 
(see [Section 6.1.1](#))



 Add Load Sensor 
(see [Section 6.1.2](#))

 Add A2B Sensor 
(see [Section 6.1.3](#))

 Add Angle Sensor 
(see [Section 6.1.4](#))

 Set Limits
(see [Section 3.6](#))

 Delete Sensor 
(see [Section 6.2](#))

 Calibrate Sensors 
(see [Section 7](#))

 Setup
(see [Section 8](#))



NOTE

The symbol  indicates that the screen is password protected. If the system is not unlocked, pressing password protected function buttons will have no function.

See [Section 8.1.2](#) for more information on unlocking the system.

6.1.1 Registering a Wind Sensor



Press F1 from the Add/Delete/Calibrate/LIM Screen. This will call up the Add Wind Sensor screen.

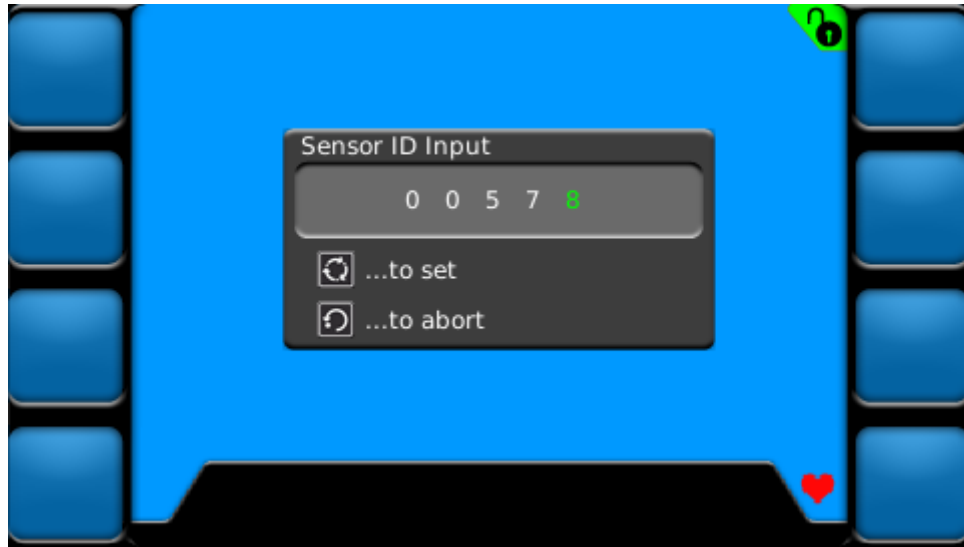



Figure 30: Add Wind Sensor Screen

Sensor ID Input is done by the following instructions:

Instructions



- When entering the screen, the first of the five digits will be highlighted in “green”
- Turn the rotary knob to change the highlighted digit to the desired number
- Once the green digit has changed to the correct number, press the rotary knob to continue to the second digit
- Continue this process until all five digits have been entered
- Once the correct ID is entered, press the SET  key to register the sensor
- To abort, press the ESCAPE  key

If SET is pressed, you will return to the Sensor Add/Delete/Calibrate/LIM Screen. If the sensor was added successfully, the load icon will appear in the next available spot in the sensor bar.



6.1.2 Registering a Load Sensor



Press F2 from the Add/Delete/Calibrate/LIM Screen. This will call up the Add Load Sensor screen.

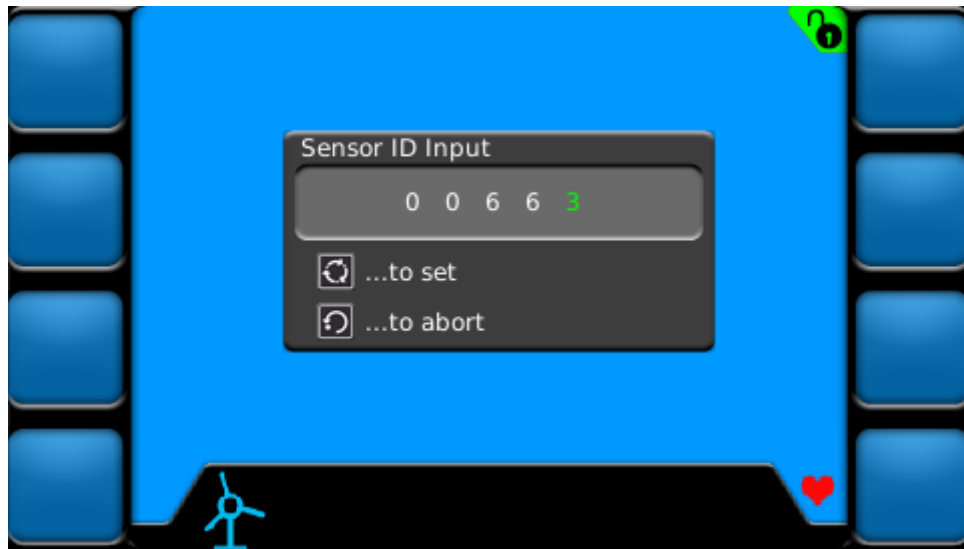



Figure 31: Add Load Sensor Screen

Sensor ID Input is done by the following instructions:

Instructions



- When entering the screen, the first of the five digits will be highlighted in “green”
- Turn the rotary knob to change the highlighted digit to the desired number
- Once the green digit has changed to the correct number, press the rotary knob to continue to the second digit
- Continue this process until all five digits have been entered
- Once the correct ID is entered, press the SET  key to register the sensor
- To abort, press the ESCAPE  key

If SET is pressed, you will return to the Sensor Add/Delete/Calibrate/LIM Screen. If the sensor was added successfully, the load icon will appear in the next available spot in the sensor bar.





6.1.3 Registering a A2B Sensor

Press F3 from the Add/Delete/Calibrate/LIM Screen. This will call up the Add A2B Sensor screen.

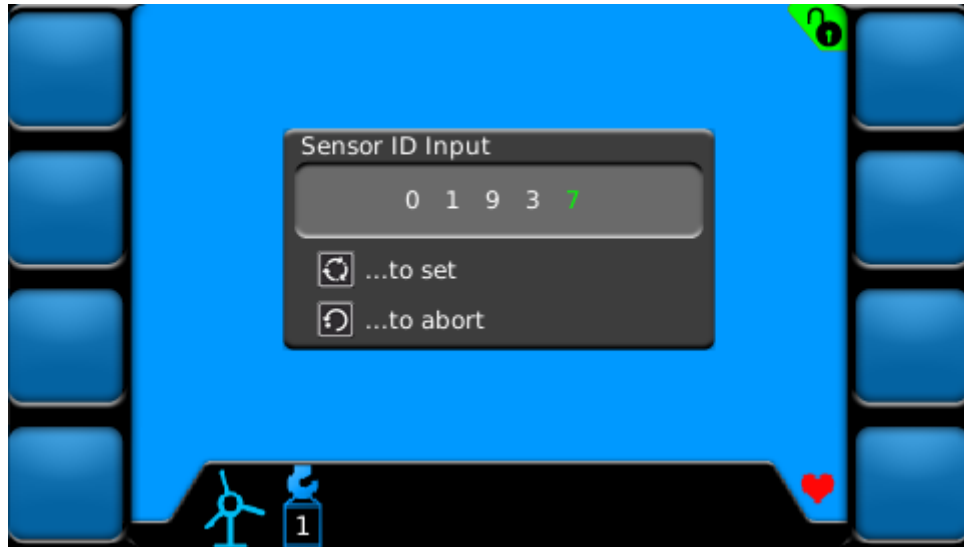



Figure 32: Add A2B Sensor Screen

Sensor ID Input is done by the following instructions:

Instructions



- When entering the screen, the first of the five digits will be highlighted in “green”
- Turn the rotary knob to change the highlighted digit to the desired number
- Once the green digit has changed to the correct number, press the rotary knob to continue to the second digit
- Continue this process until all five digits have been entered
- Once the correct ID is entered, press the SET  key to register the sensor
- To abort, press the ESCAPE  key

If SET is pressed, you will return to the Sensor Add/Delete/Calibrate/LIM Screen. If the sensor was added successfully, the load icon will appear in the next available spot in the sensor bar.





6.1.4 Registering an Angle Sensor

Press F4 from the Add/Delete/Calibrate/LIM Screen. This will call up the Add Angle Sensor screen.

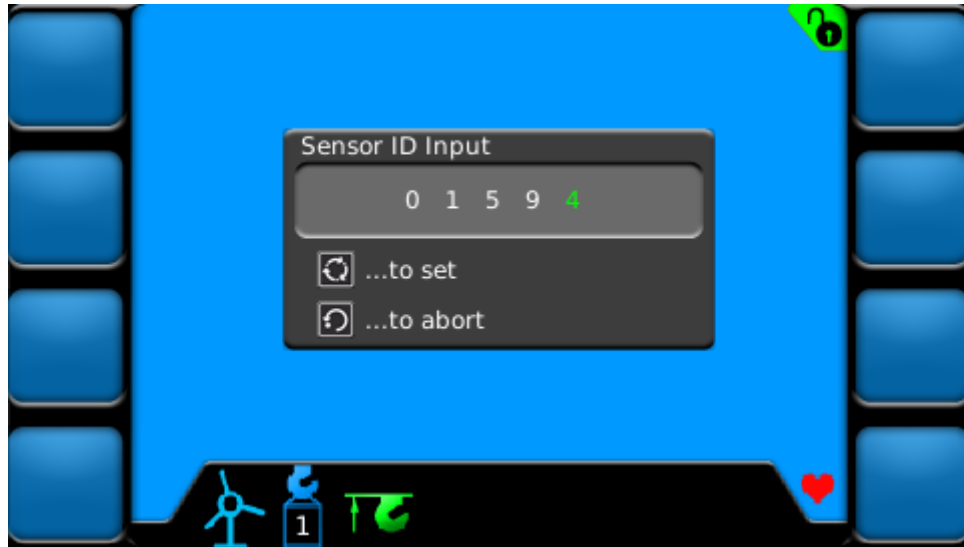



Figure 33: Add Angle Sensor Screen

Sensor ID Input is done by the following instructions:

Instructions



- When entering the screen, the first of the five digits will be highlighted in “green”
- Turn the rotary knob to change the highlighted digit to the desired number
- Once the green digit has changed to the correct number, press the rotary knob to continue to the second digit
- Continue this process until all five digits have been entered
- Once the correct ID is entered, press the SET  key to register the sensor
- To abort, press the ESCAPE  key

If SET is pressed, you will return to the Sensor Add/Delete/Calibrate/LIM Screen. If the sensor was added successfully, the load icon will appear in the next available spot in the sensor bar.



6.2 Deleting (Removing) Sensors

Wireless sensors that are no longer to be used must be deleted from the list of available sensors. To call up the Delete Sensor screen, press F6 from the Sensor Add/Delete/Calibrate/LIM Screen.



Figure 34: Delete Sensor Screen (example)

Press the corresponding function button to delete the desired sensor. When a sensor is deleted, all other sensors will keep their previous spot on the main working screen, sensor bar, and buttons.

Example If F7 is pressed, it will delete the sensor added to sensor spot 7.



Figure 35: Delete Sensor Screen (deletion example)

7 Configuring the System

If the system is used together with wireless load sensors, the rope reeving must be set (see [Section 3.5.1](#)). The sensor must also be calibrated (see [Section 7.1.1](#)).



CAUTION

The device is used together with wireless load sensors in lifting equipment with a multiple reeved lifting rope, then it is of fundamental importance for a correct load display and for the limit value monitoring to correctly input the number of rope reevings according to the actual number of rope reevings.

Therefore, the necessary inputs may only be made by operators who are familiar with the operation of the system.

If the system is used together with wireless wind sensors, the zero point of the angle sensor must be adjusted after mounting (see [Section 7.1.2](#)).

7.1 Sensor Calibration



Sensor Calibration
Screen Example

Setting the zero point is necessary after the installation of each angle and force sensor. Pressing F7 from the Sensor Add/Delete/Calibrate/LIM Screen will call up the Sensor Calibration screen.



Figure 36: Sensor Calibration Screen (example)

Function
Keys



Calibrate Load Sensor
(see [Section 7.1.1](#))



Calibrate Angle Sensor
(see [Section 7.1.2](#))



Set-Up Portion
Configuring the System



7.1.1 Calibrating Load Sensor

Press the corresponding function button to calibrate the desired load sensor. This will bring up the Load Calibration Screen for the sensor selected.

Complete the following steps to set the zero point of the load sensor. The process can be aborted at any time by hitting the ESCAPE  key.

<ol style="list-style-type: none">1. Remove all load from load sensor2. Press  to confirm this step is completed	
--------------------------------------------------------------------------------------------------------------------------------------------------------------------------------------------------------------------------	------------------------------------------------------------------------------------







7.1.2 Calibrating Angle Sensor

Press the corresponding function button to calibrate the desired angle sensor. This will bring up the Angle Calibration Screen for the sensor selected.

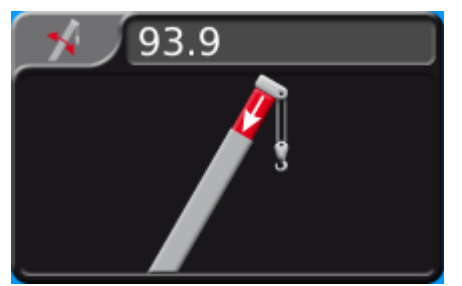
Complete the following steps to set the zero point of the angle sensor. The process can be aborted at

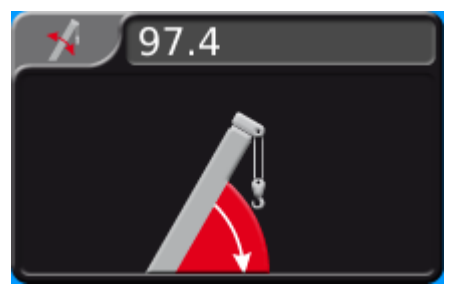
any time by hitting the ESCAPE  key.

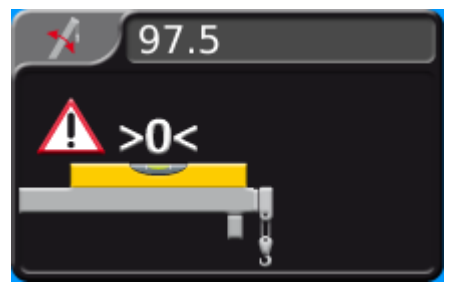
<ol style="list-style-type: none"> 1. Fully retract boom 2. Press the SET  key to confirm this step is completed 	
<ol style="list-style-type: none"> 1. Boom down 2. Press the SET  key to confirm this step is completed 	
<ol style="list-style-type: none"> 1. Lower boom to exactly 0° using a digital level on the boom 2. Press the SET  key to confirm this step is completed 	

7.2 Limit Output Signal Setup



Limit output signals can be enabled when user set limits are exceeded for load and angle sensors. Limit output signal functionality cannot be disabled for A2B sensors. This function can be set for individual sensors or in combination. To enable/disable this feature on a sensor, press the corresponding function button from the LIM screen (see [Section 3.6](#) for more information on setting limits).



NOTE

Relays will need to be added for Limit Output Signals! DOs 1-3 supply ground.

7.2.1 Enabling Limit Output Signals for Angle Sensors



Press the corresponding function button from the LIM screen to set the limit. This will call up the Angle Sensor Limit Screen. The lockout functionality is enabled or disabled by pressing the Digital Output button (F1).

Enable/Disable
Lockout

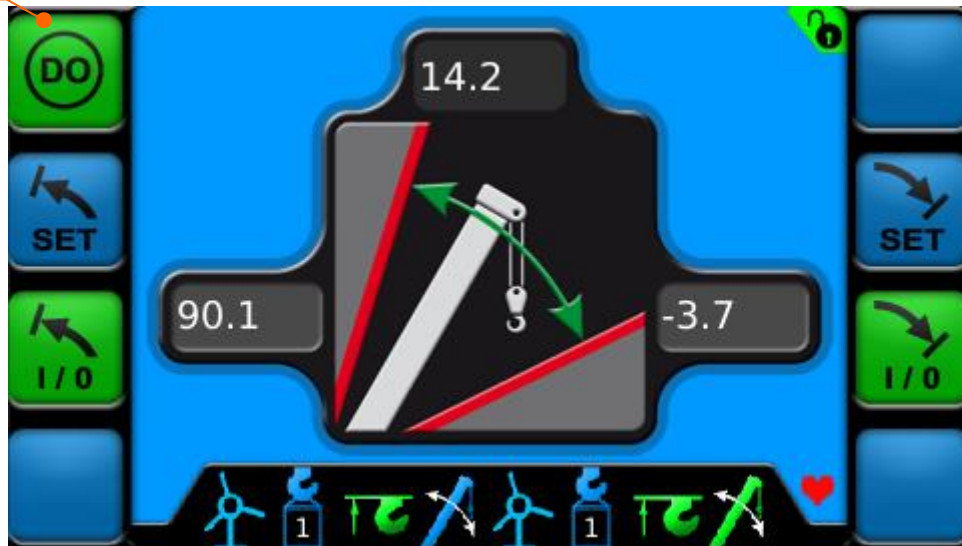



Figure 37: Set Angle Sensor Limit Screen

Instructions

Disabled	
Enabled	

7.2.2 Enabling Limit Output Signals for Load Sensors



Enable/Disable
Lockout

Press the corresponding function button from the LIM screen to set the limit. This will call up the Load Sensor Limit Screen. The lockout functionality is enabled or disabled by pressing the Digital Output button (F1).

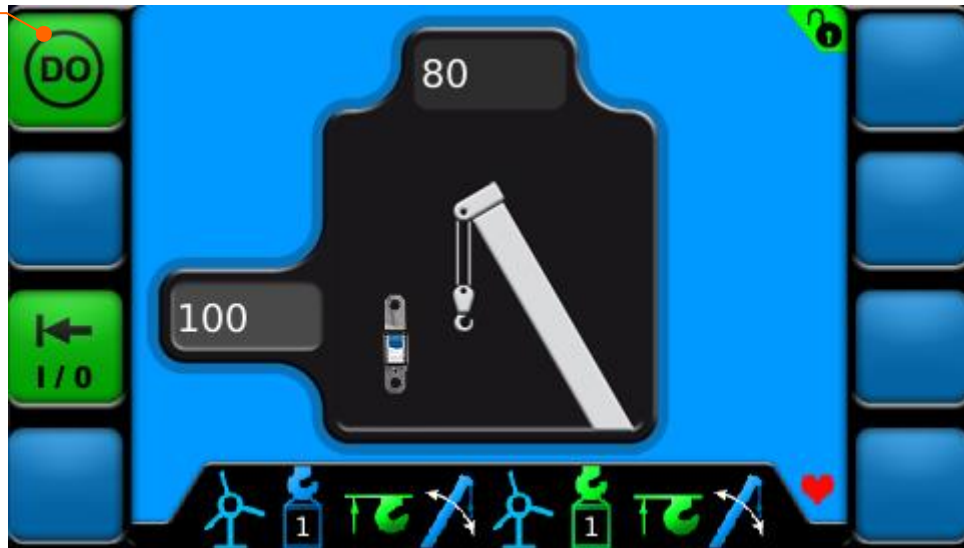



Figure 38: Set Load Sensor Limit Screen

Instructions

Disabled	
Enabled	



8 System Settings (Set-Up)

The Setup menu allows the user to configure various settings and view Digital Output statuses. Pressing F8 from the Sensor Add/Delete/Calibrate/LIM Screen will call up the Sensor Calibration screen.



Figure 39: Setup Screen

Function
Keys



LCD Brightness
(see [Section 4.1.1](#))



Sensor Information Transfer 
(see [Section 8.1.1](#))



Key Brightness
(see [Section 4.1.2](#))



Set Units
(see [Section 4.1.4](#))



Digital Outputs
(see [Section 4.1.3](#))



Lock/Unlock System 
(see [Section 8.1.2](#))



NOTE

The symbol  indicates that the screen is password protected. If the system is not unlocked, pressing password protect function buttons will have no function.

See [Section 8.1.2](#) for more information on unlocking the system.



8.1.1 Sensor Information Transfer

The sensor IDs set in [Section 6.1](#) are stored on both the vSCALE D2 console and the TRS 10-W2 wireless receiver. This is so sensor IDs do not have to be re-entered in the event of having to replace either the vSCALE D2 console **or** the TRS 10-W2.

In the event the console would need replaced, selecting F5 from the Sensor Screen will transfer the sensor ID information stored on the existing TRS 10-W2 to the new console.

In the event the TRS10-W2 would need replaced, selecting F5 from the Sensor Screen will transfer the sensor ID information stored on the existing console to the new TRS 10-W2.

The Sensor Information Transfer button will have no function if there is sensor information stored on both the console and TRS 10-W2.





8.1.2 Lock/Unlock System

Certain screens are protected by a system password. The system can be unlocked by pressing F8 in the Setup Screen. The system is locked upon start up.





Password Input is done by the following instructions:

Instructions



- When entering the screen, the first of the four digits will be highlighted in “green”
 - The Password for this system is **2034**
- Turn the rotary knob to change the highlighted digit to the desired number
- Once the green digit has changed to the correct number, press the rotary knob to continue to the second digit
- Continue this process until all four digits have been entered
- Once the correct ID is entered, press the SET  key to register the sensor
- To abort, press the ESCAPE  key

If the password was correct, the Lock/Unlock System button (F8) will change in the Setup Screen and the Lock/Unlock icon will change in the upper right hand corner of the screen. If the password was incorrect, the password input box will remain on the screen until a correct password is entered or the function is aborted.

	System Locked	System Unlocked
Lock/ Unlock System Button (F8 Setup Screen)		
Lock/Unlock System Icon		

To lock the system, press the Lock/Unlock System button (F8) from the Setup Menu a second time. The Lock/Unlock System button will change in the Setup Screen and the Lock/Unlock icon will change in the upper right hand corner of the screen.

9 Service and Maintenance

Maintenance The **vSCALE D2** operating console contains no wearing parts and therefore cannot be opened. If you notice malfunctions or differences between actual and displayed measured values, you should switch the device off and have it checked and, if necessary, repaired immediately by an authorized Hirschmann service partner.

You must always keep the full details contained on the type plate on hand.

Cleaning Clean the surface and the front screen of the device occasionally with a damp cloth and a mild detergent. Never use abrasive or aggressive detergents as these may damage the device.

IMPORTANT

Device may be damaged by the use of high-pressure cleaners.

The device must not be treated with a high-pressure cleaner or similarly aggressive method under any circumstances!

Usage Condensation inside the vSCALE console can damage electronic components or the LCD and can condense at the inner side of the front glass/touch. Although the vSCALE console is designed as a closed housing with a Gore-Tex-Membrane for breathing, condensation may occur as a physical effect, if the console is exposed to unfavorable temperature/humidity cycles, which pumps humidity inside the housing.

Repair Damage to the front foil can lead to the penetration of moisture and dirt into the interior of the device, which must then be properly repaired without delay.

Keep the contacts and the area around the device connectors clean and check occasionally that all connections are secure.

If parts are damaged, they must be properly repaired or replaced immediately.

9.1 Uploading Software



NOTE

Item needed: 2 GB or less USB flash drive uploaded with software files.

Instructions

1. Ensure the system is turned off (crane ignition key turned to the “OFF” position).
2. Insert the USB flash drive with the software loaded into the USB port on the vSCALE D2 console (see [Section 2.5](#) for more detail).
3. Press and hold F1 and F2 and turn the system ON (crane ignition key turned to “on” or ACCY” position). Continue to hold for an additional 10 seconds to ensure system recognizes the selection.

Press and hold
top two function
keys during
power up



4. The system will now begin the uploading process. The screen will begin to display various messages as the software loads. This process may take several minutes.
5. Once step 4 has been completed, the console will boot normally. You may now power down the system (crane ignition key turned to the “OFF” position).
6. You can now safely remove the USB flash drive and replace the flap.
7. The software has now been uploaded and the system is ready for use.

10 Appendix

10.1 Technical Data

10.1.1 vSCALE D2

Part Number	608413 (before software)
Operating voltage	9 - 36 V DC, suitable for 12 and/or 24 V on-board power supply
Overvoltage protection	overvoltage up to max. 48V DC / 2 minutes
Reverse polarity protection	up to -48V DC
Display	4.3", 95 mm(W) x 53 mm (H)
Brightness	400 cd/m ²
Contrast	400:1
Illumination	LED, adjustable brightness
Audible alarm	built-in, output for external horn
Operating temperature range	-40°C to +75°C
Storage temperature range	-40 °C to +85 °C
Protection class	IP 66/67, according to ISO 20653: Road Vehicles – Degrees of protection (IP-code) – Protection of electrical equipment against foreign objects, water and access
Scope of supply	<ul style="list-style-type: none"> - vSCALE D2 operating console (depending on scope of delivery with pre-fitted bracket for RAM Mount) - Mount articulated mounting - User manual (PDF file or on data storage device)

10.1.2 TRS 10-W2

Article designation	iFLEX TRS 10-W2
Article number	608799
Operating voltage	10 - 30 V DC
Fuse	Self-resetting internal fuse, 500 mA
Transmission frequency	2.45 GHz, ISM band, registration/licence-free IEEE 802.15.4 standard, DSSS /OQPSK modulated Class 1 radio system in accordance with FTEG and 1999/5/EU (R&TTE)

Set-Up Portion
 Appendix

Antenna	2.4 GHz, with magnetic base and screwed on antenna radiator, 4m connecting cable, RP-SMA plug
Range	approx. 300 m (depending upon environmental conditions)
CAN interface	ISO 11898, high-speed CAN, standard identifier (11-bit)
CAN protocol	CANopen slave CiA DS-301/DS401
Data rate	125 kbit/s (standard), 250 kbit/s, 500 kbit/s, 750 kbit/s, 1 Mbit/s
Node ID	Standard: 31 _{dec} / 1F _{hex} (configurable)
CE conformity	ETSI EN 300 328 ETSI EN 301 489-1 ETSI EN 300 489-17 EN 60950-1
FCC conformity	FCC 47 CFR Part 15, Radio Frequency Devices, Subpart B
Control elements	none
Displays	10 status LEDs for signalling various operating conditions
Electrical connection	Central connector (German) 12-pole (on underside of device)
Antenna connection	RP-SMA, coaxial (on the underside of the device)
Dimensions	H 134 mm x W 118,2 mm x D 36,3 mm
Weight	0.262 kg (device only)
Distance between mounting holes	102,1 mm
Operating temperature range	-40 °C to +85 °C
Storage temperature range	-50 °C to +85 °C
Protection class	IP 66/67

10.1 Wiring Diagrams

10.1.1 System Layout

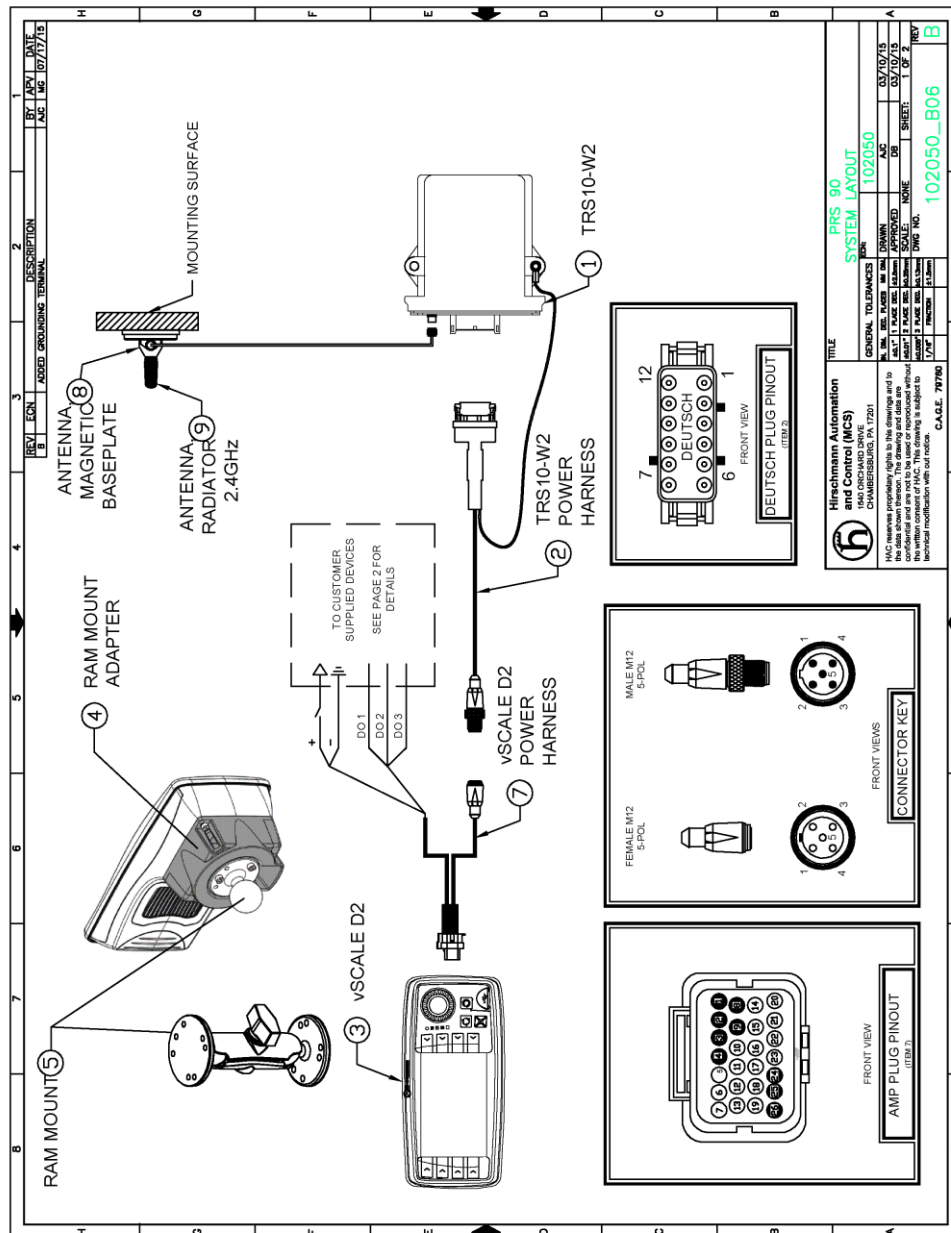

Set-Up Portion
Appendix

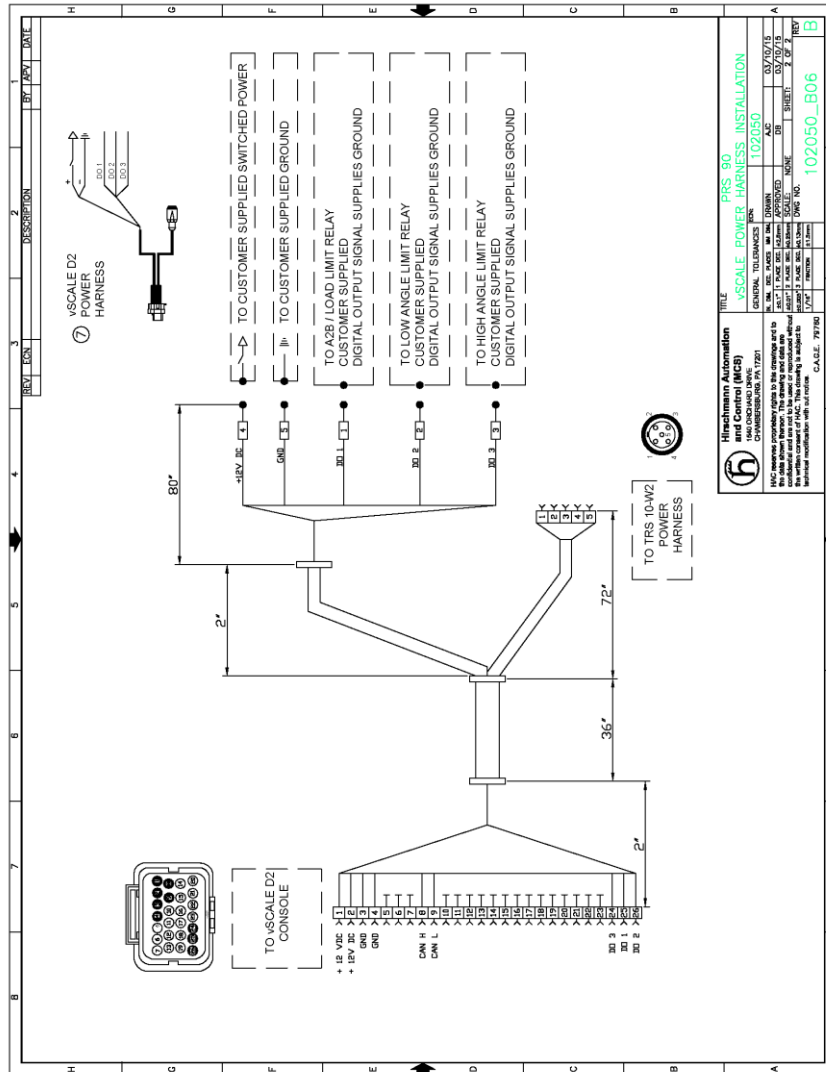

Set-Up Portion
Appendix

10.1.2 Wiring of vSCALE D2 Power Harness

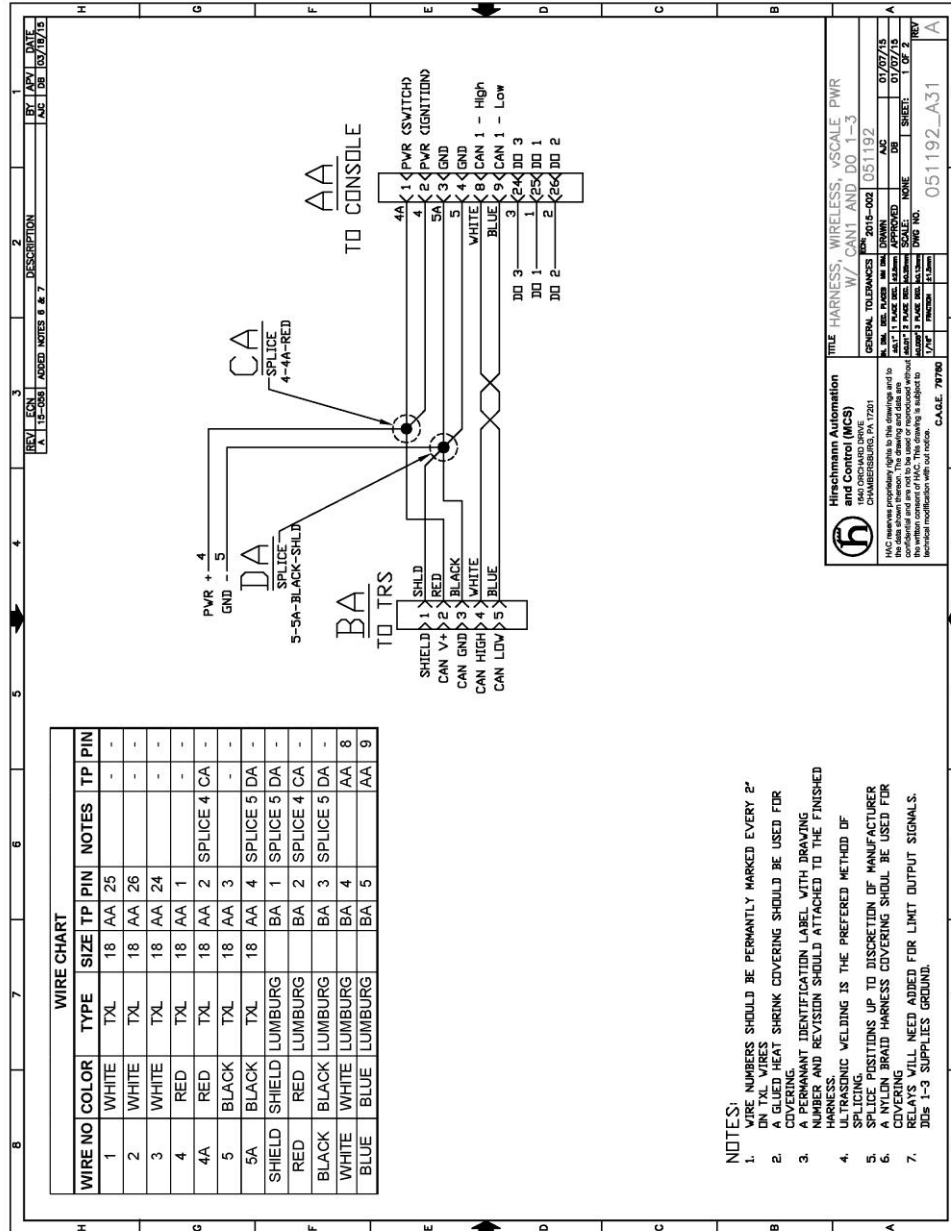

- NOTES:
1. WIRE HARNESS SHOULD BE PERMANENTLY MARKED EVERY 2' WITH WIRE NUMBER.
 2. A GULDED HEAT SHRINK COVERING SHOULD BE USED FOR COVERING.
 3. A PERMANENT IDENTIFICATION LABEL WITH DRAWING NUMBER AND REVISION SHOULD ATTACHED TO THE FINISHED HARNESS.
 4. WELDING SHOULD BE PERFORMED USING THE PREFERRED METHOD OF SPlicing.
 5. SPLICE POSITIONS UP TO DISCRETION OF MANUFACTURER.
 6. A NYLON BRAID HARNESS COVERING SHOULD BE USED FOR COVERING.
 7. RELAYS WILL NEED ADDED FOR LIMIT OUTPUT SIGNALS. JOBS 1-3 SUPPLIES GROUND.

Set-Up Portion
Appendix

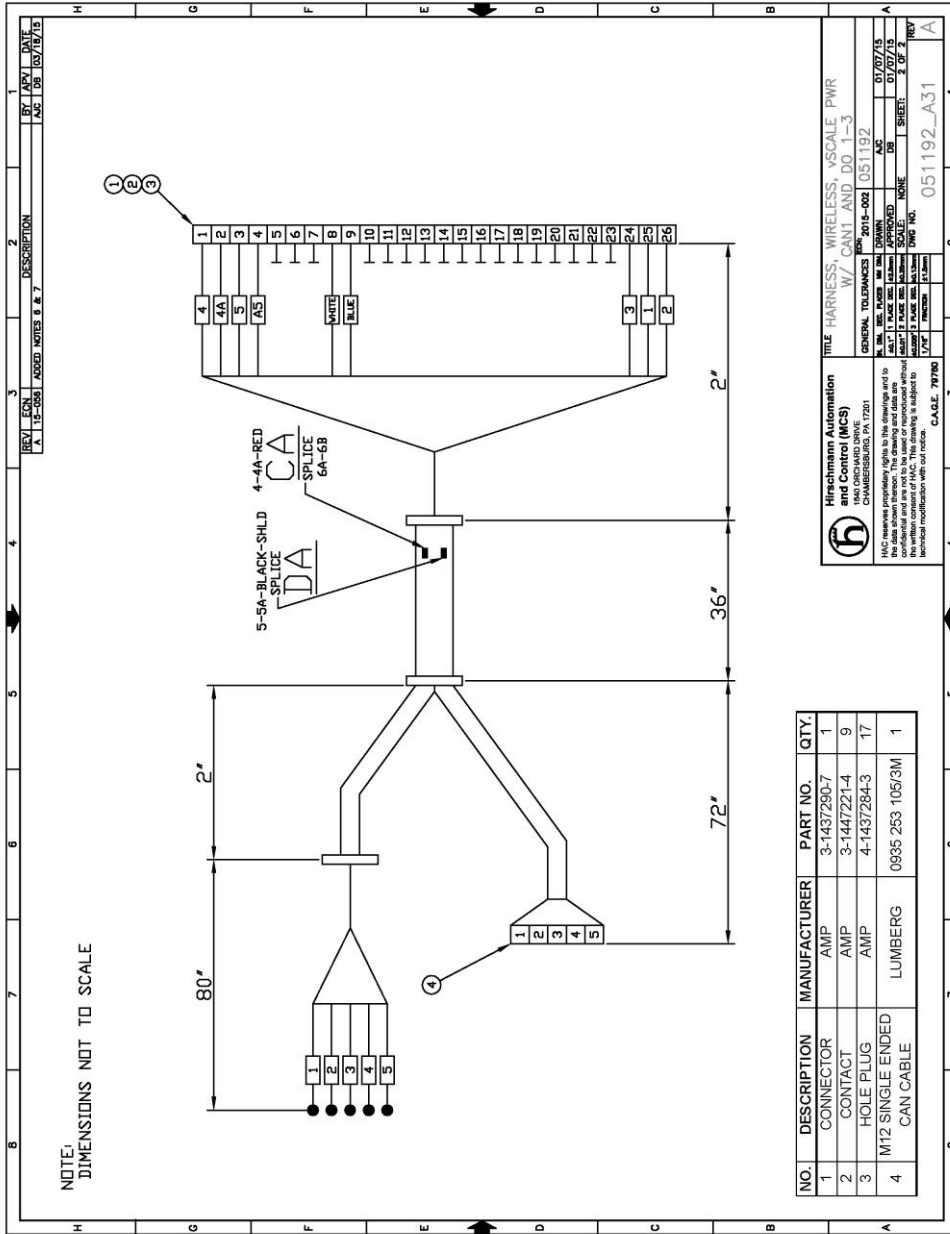

REV		DATE	BY	APP	DATE
1		08/10/15			

DESCRIPTION			
1	4	1	1
2	4A	2	2
3	5	3	3
4	5A	4	4
5		5	5
6		6	6
7		7	7
8	WHITE	8	8
9	BLUE	9	9
10		10	10
11		11	11
12		12	12
13		13	13
14		14	14
15		15	15
16		16	16
17		17	17
18		18	18
19		19	19
20		20	20
21		21	21
22		22	22
23		23	23
24		24	24
25		25	25
26		26	26
27		27	27
28		28	28
29		29	29

Hirschmann Automation and Control (MCS)		TITLE HARNESS, WIRELESS, VSCALE PWR	
CHARLESBURG, PA 17011		W/ CAN1 AND DO 1-3	
MCS reserves proprietary rights to the drawings and to the data shown thereon. The drawing and data are the property of Hirschmann Automation and Control (MCS) and are not to be reproduced in any form without the written consent of Hirschmann Automation and Control (MCS). This drawing is subject to technical modification without notice.		GENERAL TOLERANCES UNLESS OTHERWISE SPECIFIED	
FINISH: POLISHED		DIMENSIONS: PER 2015-002 051192	
SCALE: AS SHOWN		DATE: 07/07/15	
DRAWN BY: [signature]		CHECKED BY: [signature]	
MATERIAL: 1/2" ALUMINUM		SHEET: 2 OF 3	
WIRE: 1/8" DIA. BLACK ENAMELED		WIRE NO. 051192_A31	
CABLE: 79790		PART NO.	

NO.	DESCRIPTION	MANUFACTURER	PART NO.	QTY.
1	CONNECTOR	AMP	3-1437290-7	1
2	CONTACT	AMP	3-1447221-4	9
3	HOLE PLUG	AMP	4-1437284-3	17
4	M12 SINGLE ENDED CAN CABLE	LUMBERG	0935 263 105/3M	1



Set-Up Portion Appendix

10.1.3 Wiring of TRS 10-W2 Power Harness

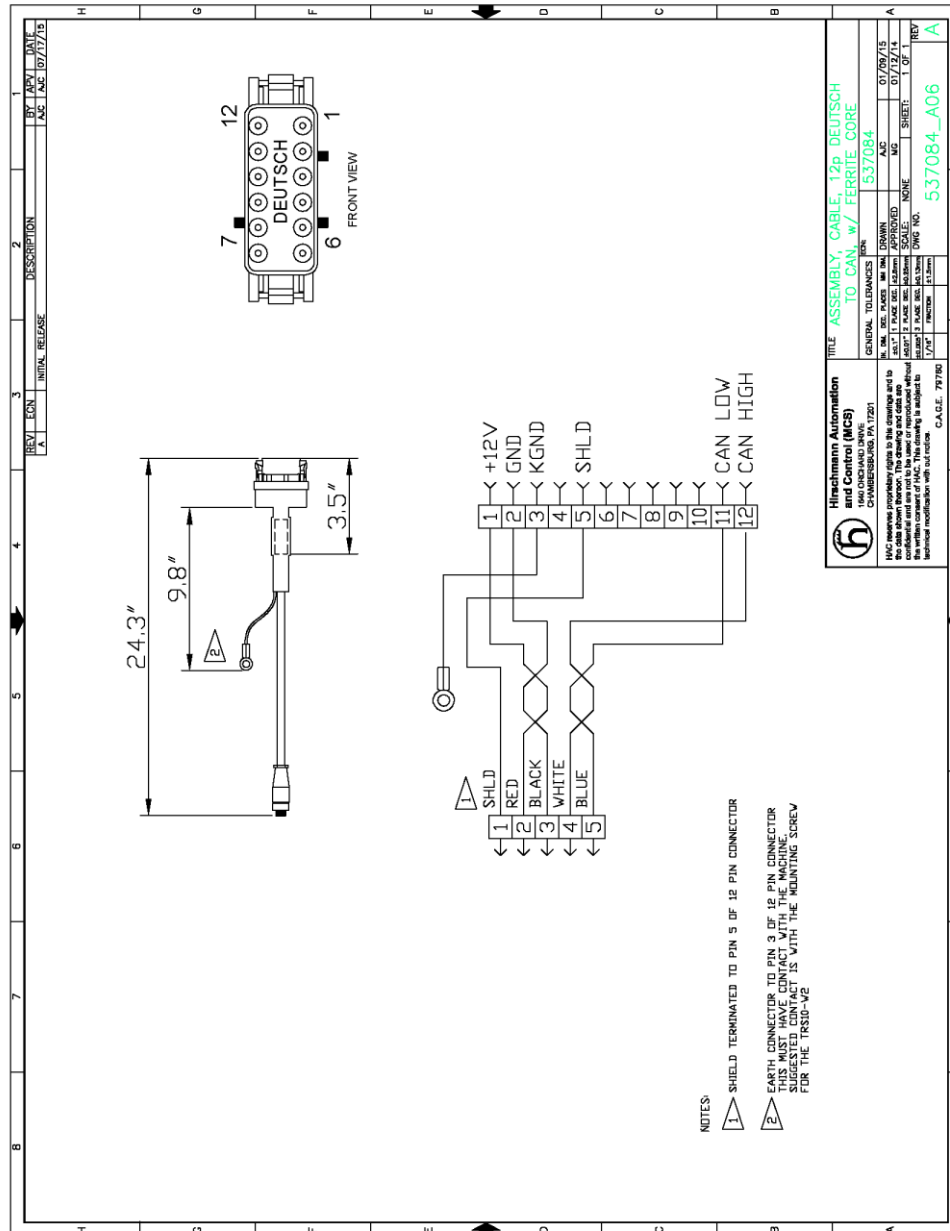

Feedback

What is your opinion about this manual? We always try to describe the products fully in our manuals, as well as providing important background knowledge to ensure trouble-free operation.

We take the task of continuous improvement and reduction of errors very seriously. Your comments and suggestions help us to increase the quality and level of information for this document.



Your assessment of this manual:

	excellent	good	satisfactory	so-so	poor
Accuracy	<input type="radio"/>	<input type="radio"/>	<input type="radio"/>	<input type="radio"/>	<input type="radio"/>
Readability	<input type="radio"/>	<input type="radio"/>	<input type="radio"/>	<input type="radio"/>	<input type="radio"/>
Comprehensibility	<input type="radio"/>	<input type="radio"/>	<input type="radio"/>	<input type="radio"/>	<input type="radio"/>
Examples	<input type="radio"/>	<input type="radio"/>	<input type="radio"/>	<input type="radio"/>	<input type="radio"/>
Structure / Layout	<input type="radio"/>	<input type="radio"/>	<input type="radio"/>	<input type="radio"/>	<input type="radio"/>
Completeness	<input type="radio"/>	<input type="radio"/>	<input type="radio"/>	<input type="radio"/>	<input type="radio"/>
Illustrations / Images	<input type="radio"/>	<input type="radio"/>	<input type="radio"/>	<input type="radio"/>	<input type="radio"/>
Drawings, Diagrams	<input type="radio"/>	<input type="radio"/>	<input type="radio"/>	<input type="radio"/>	<input type="radio"/>
Tables	<input type="radio"/>	<input type="radio"/>	<input type="radio"/>	<input type="radio"/>	<input type="radio"/>

Did you discover errors in this manual?

If so, on which page?

Set-Up Portion
Appendix

Suggestions for improvement and additional information:

General comments:

Sender:

Company / Department

Name / Phone

Street

Zip code / City

Date / Signature

Dear user,

please complete and return both pages of this feedback:

- via Fax an: +49 (0)7243 709 3222
- via Post an: Hirschmann Automation and Control GmbH
Documentation
Hertzstr. 32-34
76275 Ettlingen

Thank You !

