

**W1250  
LOAD MOMENT**

**OPERATOR'S MANUAL**

**Version 3.1**

**Wylie Systems**

Drury Lane  
St. Leonards-on-Sea  
East Sussex  
TN38 9BA

Tel:+44 (0) 1424 421235  
Fax:+44 (0) 1424 433760

**Wylie Systems**

1020 9<sup>th</sup> Avenue, SW  
Suite 124, Bessemer  
AL 35022  
U.S.A

Tel:+1 (205) 481-2080  
Fax:+1 (205) 481-2081

**Rayco Electronic System**

2440 Ave Dalton  
Ste-Foy  
Québec G1P 3X1  
Canada

Tel:+1 (418) 266-6600  
Fax:+1 (418) 266-6610



**INDEX**

INDEX .....	3
JOB DATA .....	5
1. INTRODUCTION .....	6
1.1 System .....	6
1.2 Intelligent System .....	6
1.3 Adaptability .....	6
2. HOW THE INDICATOR WORKS .....	7
2.1 Load sensor .....	7
2.2 Amplifier .....	7
2.3 Angle sensor .....	7
2.4 Length sensor .....	8
2.5 Anti-two-block switch .....	8
2.6 Display .....	8
3. INSTALLATION .....	11
3.1 Load sensor .....	11
3.2 Amplifier .....	11
3.3 Angle sensor .....	11
3.4 Cable storage drum .....	11
3.5 Recoil cable reel .....	11
3.6 Length sensor .....	12
3.7 Anti-Two-Block switch .....	12
3.8 Display .....	12
4. CALIBRATION .....	26
4.1 General .....	26
4.2 Crane Preparation .....	26
4.3 Indicator Preparation .....	26
4.4 Internal Amplifier Setting .....	26
4.5 External amplifier setting .....	28
4.4 Calibration procedure .....	28

**INDEX (CONTINUED)**

5. DISPLAY DESCRIPTION ..... 28

    5.1 Display Panel.....28

    5.2 Bar Graph.....29

    5.3 Key Board.....30

    5.4 Indicator Lights .....31

    5.5 LCD Screen.....31

6. OPERATING INSTRUCTION ..... 32

    6.1 \*\*\* Warning \*\*\* .....32

    6.2 Operating procedures.....32

    6.3 DISPLAY button .....33

    6.4 LIMITS Button.....35

    6.5 HOIST Selection.....36

    6.6 PARTS OF LINES Button.....36

    6.7 BOOM / JIB Button.....37

    6.8 CONFIG / DEDUCT (One Selection).....38

    6.9 CONFIG / DEDUCT: (Multiple Selections Only) .....39

    6.10 BYPASS Button.....40

    6.11 RIG Button.....41

    6.12 Quick Tricks.....41

7. QUICK REFERENCE SHEET ..... 41

8. TROUBLE SHOOTING..... 42

    8.1 Error Code.....42

    8.2 Diagnostic Menu.....44

9. ROUTINE MAINTENANCE ..... 48

10. PERFORMANCE CHECK ..... 49

PERIODICAL TEST SHEET ..... 50

REFERENCE TABLES ..... 51

    Control Wiring.....51

    Dip Switch .....52

    Internal Amplifier.....53

    External Amplifier .....54

    Key Board.....54

    Indicator Lights .....55

    Error Code.....56

**JOB DATA**

DATE:

\_\_\_\_\_

CUSTOMER:

\_\_\_\_\_

MACHINE:

\_\_\_\_\_

CHART'S FILE:

\_\_\_\_\_

PROG. BY:

\_\_\_\_\_

OPERATING SYSTEM:

\_\_\_\_\_

ANGLE SENSOR:

\_\_\_\_\_

LENGTH SENSOR:

\_\_\_\_\_

LOAD SENSOR 1:

\_\_\_\_\_

SENSOR MOUNTING 1:

\_\_\_\_\_

LOAD SENSOR 2:

\_\_\_\_\_

SENSOR MOUNTING 2:

\_\_\_\_\_

A2B:

\_\_\_\_\_

WIRES:

\_\_\_\_\_

CONNECTORS:

\_\_\_\_\_

SPECIAL NOTES:

\_\_\_\_\_

COMPLETED AND TESTED BY:

\_\_\_\_\_

## **1. INTRODUCTION**

### **1.1 System**

The Wylie W1250 Load moment indicator is a length, load, angle, radius, and lifting capacity and anti-two-block indicator. A display in the cab or near the operator will give the operator all the necessary information to prevent from guessing when using his crane. The system can also be set with limits by the operator to warn the operator of an accidental maneuver into an unwanted area.

### **1.2 Intelligent System**

The system is microprocessor based meaning that there is a computer inside the box with operating software. This software has four parts, each has a distinct mode allowing different functions: The normal operating mode, the calibration mode, the diagnostic mode and the setting mode.

The normal mode is the normal operating status of the unit when turned on. It is the only mode an operator should know. In this mode the operator will read the hook load, the radius, the angle, etc. and he will be able to set the limits, the hoist, the parts of lines and the boom configuration.

The calibration mode that allows the calibration of the sensors, the radius and other various variables can be accessed by pressing a group of keys on the keypad simultaneously. No other unit is necessary to calibrate the system.

The diagnostic mode allows troubleshooting of the unit without the need of a voltmeter. It can be accessed by pressing a group of keys on the keypad.

The setting mode allows the initial setting of the device. This mode also allows the setting of the number of load sensors up to four. This mode is not available to users and will not be discussed in this manual.

### **1.3 Adaptability**

The system is designed to be fitted on any crane from conventional to telescopic and from 1 to 4 hoists. Thus its components can vary substantially from one machine to another.

There is different software for conventional and telescopic crane to convert from a sensor controlled boom length to an operator set boom length. This is the only difference in the two software. Make sure that the system's software has 1250L for conventional or lattice cranes. Further details on selecting the boom length are shown in the operating section.

The software is located in two CHIPS on the CPU board inside the display box. Along with the software version, the CHIPS also contain the crane's rated capacity charts. Both information are written on a label glued to the CHIP's surface.

The heart of the W1250 is the display unit. This box contains all electronic components required transforming sensor signals into the required information for the operator.

The other components are the angle sensor, the length sensor, the load sensors and the Anti-two-block switches. All the above are connected to the display unit to provide the basic data.

There are two types of angle sensor, one type of length sensor, six types of dynamometers and dead end load sensors, two types of Anti-Two-Block switch. The choice of sensor is depending on the type of crane, the required accuracy, the dismantling facility and the budget of the customer.

It is also possible in certain situations to use signal conditioners between the sensors and the display unit. This will not change the accuracy of the system but will prevent radio interference and loss of signal through connectors or slip rings.

Junction boxes are also sometime used to reduce the amount of wires going to the display box. They have no other purpose than to simplify.

## **2. HOW THE INDICATOR WORKS**

### **2.1 Load sensor**

#### **THREE SHEAVE DYNAMOMETER**

The dynamometer is a hoist line load sensor. It consists of a load cell applied against the middle sheave of a three-sheave arrangement. The three sheaves are positioned in a way that deflects the hoist line by a few degrees. When tensioned, the hoist line tends to straighten. This applies a force on the middle sheave against the load cell. The force is proportional to the hoist line tension. The hoist line tension is also proportional to the hook load (except for sheave friction).

#### **FIVE SHEAVE DYNAMOMETER**

A hoist line sensor that consists of a load cell applied to the middle sheave of a five-sheave arrangement. The end sheaves are used only to keep the hoist line in contact with the second and fourth sheave. The hoist line is deflected by the middle sheave in a ratio from 6: 1 to 12: 1 upon the rope size. The advantage of this design over the three-sheave arrangement is that all the sheaves are on the same side. This compensates for rope wear.

#### **HOW THE LOAD CELL WORKS**

The load cell used for all the load sensors work with the same principle. The load cell operates on the basis of a wheastone bridge. This means that four variable-resistors of equal value are bonded to the weakest part of the load cell. When a load is applied, it changes the value of the resistors in opposite direction causing a voltage variation on the output wires. The voltage variation is to the order of thousandths of volts. The voltage output being so small, it could be sensitive to radio interference and wire resistance between the load cell and the control unit. Therefore, in some cases, an amplifier is used to insure good transmission of the signal.

### **2.2 Amplifier**

The amplifier is used when the distance between the load cell and the control unit exceeds 80 feet. Beyond that distance, radio waves and wire internal resistance may noticeably influence the load cell signal. The amplifier is also used when the signal wires of load sensor as well as other sensors like angle or length must go through a slip ring.

The amplifier simply amplifies the load cell millivolt output into a 0-5 Volt signal, then in a second stage, it converts the signal into a 4-20 mA output. The signal is then no longer sensitive to radio interference or internal wire resistance, internal wire or slip ring resistance.

### **2.3 Angle sensor**

#### **PENDULUM TYPE**

The pendulum type is basically a high precision one-turn pot driven by a heavy pendulum. The pendulum will keep the pot's knob pointing toward the ground regardless of the angle of the boom. The resulting voltage output from the pot is proportional to the angle of the boom.

## LIQUID TYPE

The liquid type angle sensor consists of two electrodes with a semi-conductor liquid in between. The electrodes send pulses through the liquid which has a capacitate property. When the electrodes are fully immersed, the capacity is at its highest. As the boom angle changes, less electrode surface is in the liquid causing a small capacity. An internal circuit converts the pulse output in an analog output almost identical to the pendulum type signal.

### **2.4 Length sensor**

The length sensor is a potentiometer located inside the reeling drum used on telescoping cranes. As the boom extends, the reeling drum unwinds and the potentiometer is gear driven. The output is proportional to the boom extension.

### **2.5 Anti-two-block switch**

The Anti-Two-Block switch is a spring-loaded switch. It is attached to the boom tip on one end and to a chain leading to a weight clamped around the hoist line at the other end. When the hook block lifts the weight, the switch becomes disengaged and the signal is cut.

### **2.6 Display**

The display is both the operator display panel and the processing unit. In it, the sensor signals are read and computed to determine the angle, the radius, the load and the capacity. The results are then displayed to the operator using a liquid Crystal display screen, indication lights and a bar graph located on the same box. The display is composed of three sections:

#### THE INPUT BOARD

The input board has all the wire connections. On this board, the signals are conditioned to be legible for the processor. The supply voltage is reduced from an input range of 11 to 28 VDC to 5 VDC to supply both the processor and the sensors. The supply voltage is also reduced to 10 VDC for the warning lights on the display panel.

The reduced voltages are sent up to the other board via a Molex connector and loose colored wires. It can be unplugged by pulling gently downward on the colored wires.

The processed signals from the sensors are sent up to the other board via a flat ribbon connector. This connector can be unplugged when the power is OFF by pulling open the side clamp of the connector on the board.

On this board are two fuses, the top one protects the supply voltage to the unit. If blown, the unit is OFF. Use a 2 amp 5X20mm to replace. The bottom fuse protects the VP terminals used to forward voltage to external switches and amplifiers. Use a 1 amp 5x20mm to replace.

There is a dry contact relay for lockout and external alarm. It has only a 2 amp on 24 VDC rating. It is used to control a slave relay. The terminals available are common, normally open and normally closed.

Two other relay output drivers exist and are used in special applications to drive additional external relays. There is a serial communication port RS 232 on the terminal strip identified as TX, RX and 0V. It can be used for a printer or to communicate with the microprocessor.

On the top right of the board is found a multiplexed amplifier to condition load cell input. This board can multiplex 4 load cell signals. The amplified load cell signal is routed two different ways. The first is AIN6 that is a direct input into the microprocessor. The second route is to a frequency converter that converts the sensor signal into a pulse with variable



width. The width of the pulse is then measured by the High Speed Input of the processor in increments of one microsecond. This means that if the load cell signal is converted into a 1-second pulse, the processor could measure the load cell signal with a resolution of one millionth. Of course, one second is a long time when quick response is needed, and therefore a shorter span is used with less resolution to optimize speed and resolution.

Load cell sensor signals can be supplied to the board in the form of millivolts (direct load cell output), analog 0 to 5 volts, analog 0 to 1,2 or 3 volts and current 4-20 mA. All other analog sensor signals can be supplied in 0 to 5 volts or any portion of it with a span of 1 volt or more or in current 4-20 mA or any other current loop that is ground referenced.

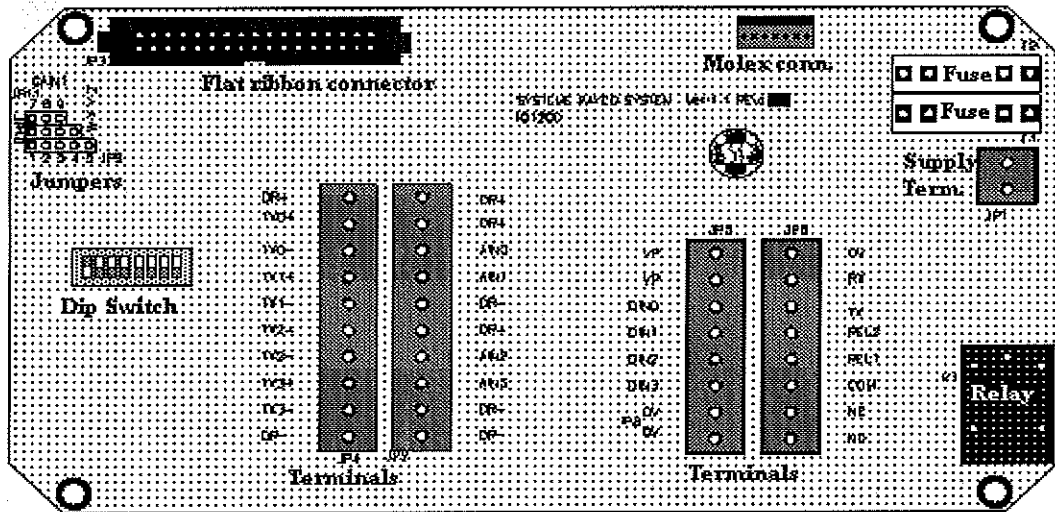

**Din Description**

- 0 Anti-two-block
- 1 Used for Duty Selection from slew switch
- 2 Used for special duty selection when needed
- 3 Used for Motion Cut Bypass

**Ain Description**

- 0 Boom Angle
- 1 Boom Length
- 2 Direction sensor main hoist
- 3 Direction sensor aux. Hoist

**TX Description**

- 0+ Positive signal of the load sensor on main hoist
- 0- Negative signal of the load sensor on main hoist
- 1+ Positive signal of the load sensor on aux. hoist
- 1- Negative signal of the load sensor on aux. hoist
- 2+ Positive signal of the load sensor on whip1 hoist
- 2- Negative signal of the load sensor on whip1 hoist
- 3+ Positive signal of the load sensor on whip2 hoist
- 3- Negative signal of the load sensor on whip2 hoist

## THE CPU BOARD

The Central Processing Unit board has for function to read all the sensor signals. Using the stored calibration data, the CPU converts the signals into the various information like boom angle, length, radius and hook load. The CPU also compares the information with the set limits entered by the operator. The CPU will finally trigger the alarms and lockout output if a limit is reached or if a two-block situation is sensed.

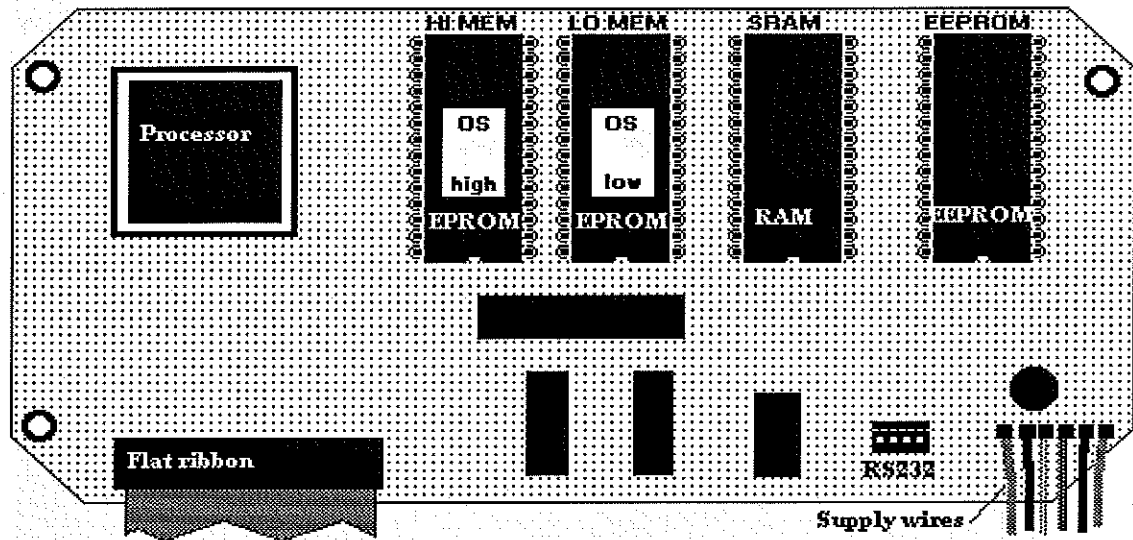

The CPU board is composed of a processor in the INTEL family. It is a 16-bit processor running at 8 MHz internal and external. This microprocessor is capable of handling up to 64,000 addresses. It is comparable to the 80286 in general speed and features. Most other processors used for LMIs are 8 bit processor running at 1 MHz and capable of handling up to 256 addresses. They can be compared to the first Apple 2E or the Commodore 64. The net advantage of this is the capability of doing more calculations faster to yield an accurate hook load reading instantaneously.

The CPU board also contains the RAM, the EPROM, the EEPROM, the PAL and various other less important dedicated CHIPS.

The RAM is the Random Access Memory, the processor memory. It stores all the calculated variables while operating. It is available in battery backed up SRAM. In this case, calculated data like lifts can be stored in memory until retrieved or printed.

The EPROM contains the operating system. On desktop computers it is called the DOS (disk operating system), on this system, it is called the O.S. (operating system). It is the O.S. that tells the system what it is and what it is supposed to do. In this case, a load moment indicator based on dynamometers or hydraulic pressure. Attached to the O.S. are the programmed crane charts. They are attached rather than on a separate CHIP because the system runs on 16 bits and the EPROM CHIPS are 8 bits. Therefore, two CHIPS are required to read one file. To save on space and cost, both the O.S. and the charts are on the same file. The use of 16 bit CHIPS would be more costly and difficult to obtain. The first CHIP is called LOW MEMORY and the second is called HIGH MEMORY. Each CHIP has its own location on the board and a direction for insertion. The notch on the CHIP must line up with the one drawn on the board. If the charts need to be modified or the operating system upgraded, it is done by replacing both CHIPS.

The EEPROM is the calibration CHIP. It stores permanently the entire calibration data specific to a particular crane. The information is stored in two banks on the same chip. It is useful to have two banks in case something is calibrated wrong. Then, the second

bank can be brought back and the calibration can resume without starting from scratch. The default bank is called A and the spare bank is called B.

### THE DISPLAY BOARD

This board is the operator interface. It contains the alpha-numerical liquid Crystal display on which appear such information as boom length, angle, radius, hook load, preset limits, failure messages, hoist used and parts of lines. It contains the processing circuitry for the 8-button keypad. It contains the 8 indicator lights for alarms and status information. Finally it contains the 10 indicator lights used in the overload barograph. This barograph is used to compare the hook load and the rated capacity.

## 3. INSTALLATION

### 3.1 Load sensor

A typical installation drawing is supplied with the indicator. This will vary depending on the type of load sensor and the type of crane (See drawing in section 3.9).

A special drawing may be supplied for particular application.

Before and after installing, make sure that the load sensor operates properly at all boom angles and that fleet angles are respected.

Make sure the mounting bracket is sufficiently strong to support the load sensor and the forces applied on it.

Refer also to the specification sheet for additional information concerning the load sensor and its suitability for the application. Wire the amplifier or junction box according to supplied drawing.

### 3.2 Amplifier

A typical installation drawing is supplied with the indicator. This will vary depending on the type of load sensor and the type of crane (see drawing in section 3.9).

The amplifier is usually mounted on the dynamometer. Use a tap 1/4 x 20 to thread the hole before mounting. If a multi-amplifier is supplied because of slip rings, mount the box on the turret part of the crane with the cable glands pointing downward. Wire according to supplied drawing.

### 3.3 Angle sensor

A typical installation drawing is supplied with the indicator. This will vary depending on the type of angle sensor and the type of crane. In some cases, the angle sensor is pre-assembled inside the reeling drum (See drawing in section 3.9).

Special attention must be given to the side of the boom on which it is mounted. If mounted on the left side of the boom, the angle indicator must be oriented in a specific direction that is different from the right side of the boom. Wire according to supplied drawing.

### 3.4 Cable storage drum

A typical installation drawing is supplied with the indicator. This will vary depending on the type of storage drum and the type of crane (See drawing in section 3.9).

### 3.5 Recoil cable reel

A typical installation drawing is supplied with the indicator. This will vary depending on the type of cable reel and the types of crane (See drawing in section 3.9).

The reeling drum can be mounted spooling out from under or over. This enables installation on either side of the boom. However, it is recommended that the reeling drum be installed on the cab side. This way, the operator can keep an eye on the cable in case it gets caught. If needed, the cable reel can be reversed on site. See specification sheet for the procedure. Rotating the spring is a dangerous maneuver if not done properly.

The cable reel is generally mounted in the middle of the first section, positioned away from all external ribs and weld lines. The height of the reel depends on anchoring at the boom tip. Make sure the anchor at boom tip will not interfere with the jib or any other parts. Make sure the cable will not rub on any web, as this will cause wear. The reeling drum does not have to be mounted vertically but esthetically it is better.

The reeling drum must be bolted parallel to the cable direction. If out of alignment, the cable will pile up on one side of the drum yielding inaccurate boom length.

The first cable guide is very important. If too close to the reel (less than 3 feet), the cable will tend to pile up in the center of the drum. If too far (greater than 8 feet), strong winds may cause the cable to jump off the drum.

The first guide must be centered with the reel off point. The other guides, one at the end of each section must be perfectly in line horizontally and vertically with the reel off point. In a perfect installation, the cable barely touches any of the guides.

The cable on the cable reel can be supplied with one, two or three conductors. Some conductors may be used for special switches or sensors at boom tip. Generally, one conductor is used for the A2B switch. The A2B switch works with one conductor, using the boom as the other conductor. The advantage to this is the increased durability of the cable and the lower cost for replacement. However, some cranes have poor conductivity between boom sections; requiring the use of two conductors for the A2B switch.

The length sensor should already be mounted inside the reel. The angle sensor may be mounted inside as well. The A2B signal, the angle signal and the length signal will be connected to the same outgoing wire fed from the center of the reeling drum.

Wire according to supplied drawing (See drawing in section 3.9)

### **3.6 Length sensor**

The length sensor is usually pre-installed inside the reeling drum. If mounted on a different reeling drum, a special drawing will be supplied. Wire according to supplied drawing.

### **3.7 Anti-Two-Block switch**

A typical installation drawing is supplied with the indicator. This will vary depending on the type of switch and the types of crane (See drawing in section 3.9).

If two switches will be used at the same time, make sure the proper switch or junction box is used at the boom tip.

If only one switch will be used but moved from the main tip to the jib tip, it can be achieved with the same cable reel or an extension wire. If using the cable reel, make sure the cable reel pay out will allow mounting to the end of the jib.

No wiring is needed, a standard connector is supplied for the switch. If a junction box is used, wire according to the supplied drawing.

### **3.8 Display**

The display should be located at the front of the cab, where it is readily visible from the operator's control position. Take care not to obscure any displays, control levers, or switches, etc.

Leave sufficient room for the sensor wires to be fed from the bottom of the display.

The screen contrast is factory set. However, it can be adjusted on site. Open the cover, just under the cover on the display board is a small screw adjustment. Turning right will darken. Note that the screen will darken slightly as the temperature increase and fade slightly as the temperature decreases. If the unit will be operated in a hot climate, it is better to reduce the contrast. If the unit will be operated in a cold climate, it is better to increase the contrast slightly.

If the unit is pre-wired with connectors, simply plug in the connectors. If the unit is not pre-wired, continue with the following instructions.

Loosen the four top screws and flip the cover over the box. Proceed gently in order not to damage the wires or the keypad.

Wire according to the supplied drawing (See the JOB DATA sheet for the drawing number). Wire resistors or jumpers if any as shown on drawing. Make sure all connections are done properly and completed before powering the system. When stripping wires, do not drop the ends, the copper threads or the shield threads in the box.

All wires' shields should be grounded to the cable glands of the display box only. Follow figure 3.7. Fold the shield over the rubber sleeve. Use the brass ring for 2,3 and 4 lead wires.

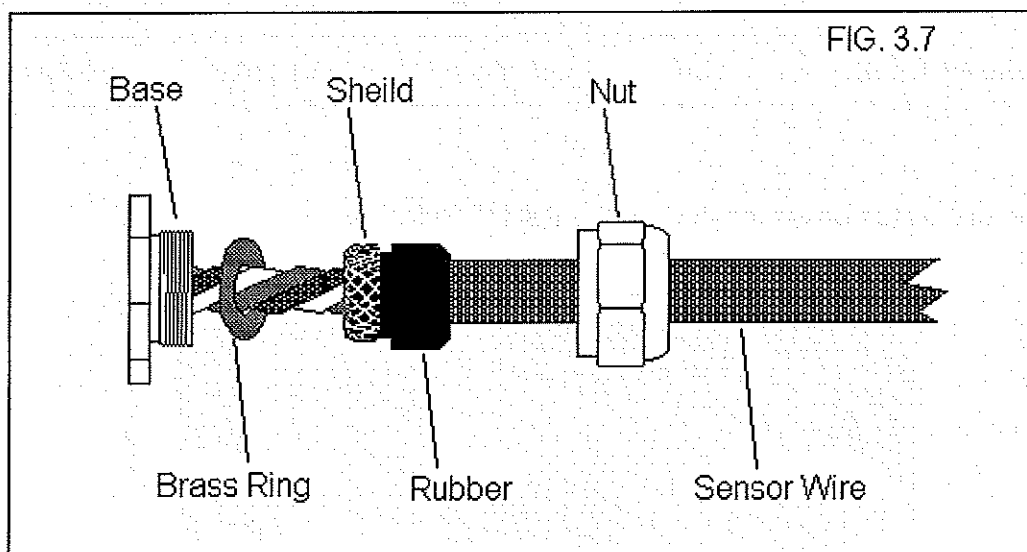

Power supply must be from 11 to 28 Volts DC only. If not available, an external power supply to convert to 12 Volts DC is required. Power lead must be able to sustain a minimum of 11 Volts with a current of 5 amps if the unit is connected to a lockout device.

Lockout wires should not load more than 2 amps on the internal relay.

No wires should be passing near a radio antenna. All wires must be shielded.

All wires must be fed away from mechanical parts, keep a minimum bending radii of two inches when static and 4 inches when moving.

**DIP SWITCHES**

The dip switches are usually preset. However, if a change is required on site because an amplifier has been added, it can be done as follow:

<b>SWITCH</b>	<b>STANDARD</b>	<b>REASON</b>
Dip switch 1:	ON	Always on
Dip switch 2:	OFF	Always off
Dip switch 3:	OFF	Always off
Dip switch 4:	OFF	Always off
Dip switch 5:	ON	Off only if a fourth load sensor is installed
Dip switch 6:	ON	Off only if a third load sensor is installed
Dip switch 7:	OFF	Only if AUX. load sensor has a 4-20 mA input
Dip switch 8:	OFF	On only if MAIN load sensor has a 4-20 mA input

The dip switch box is located on the INPUT BOARD:

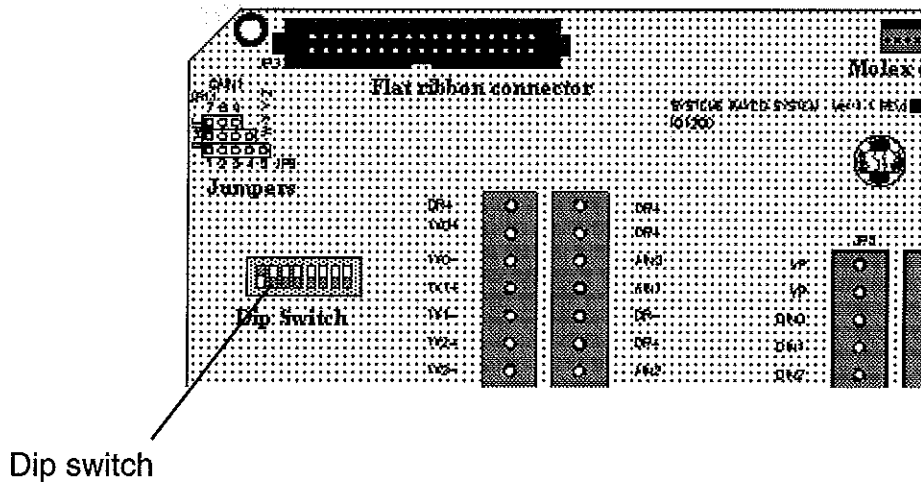

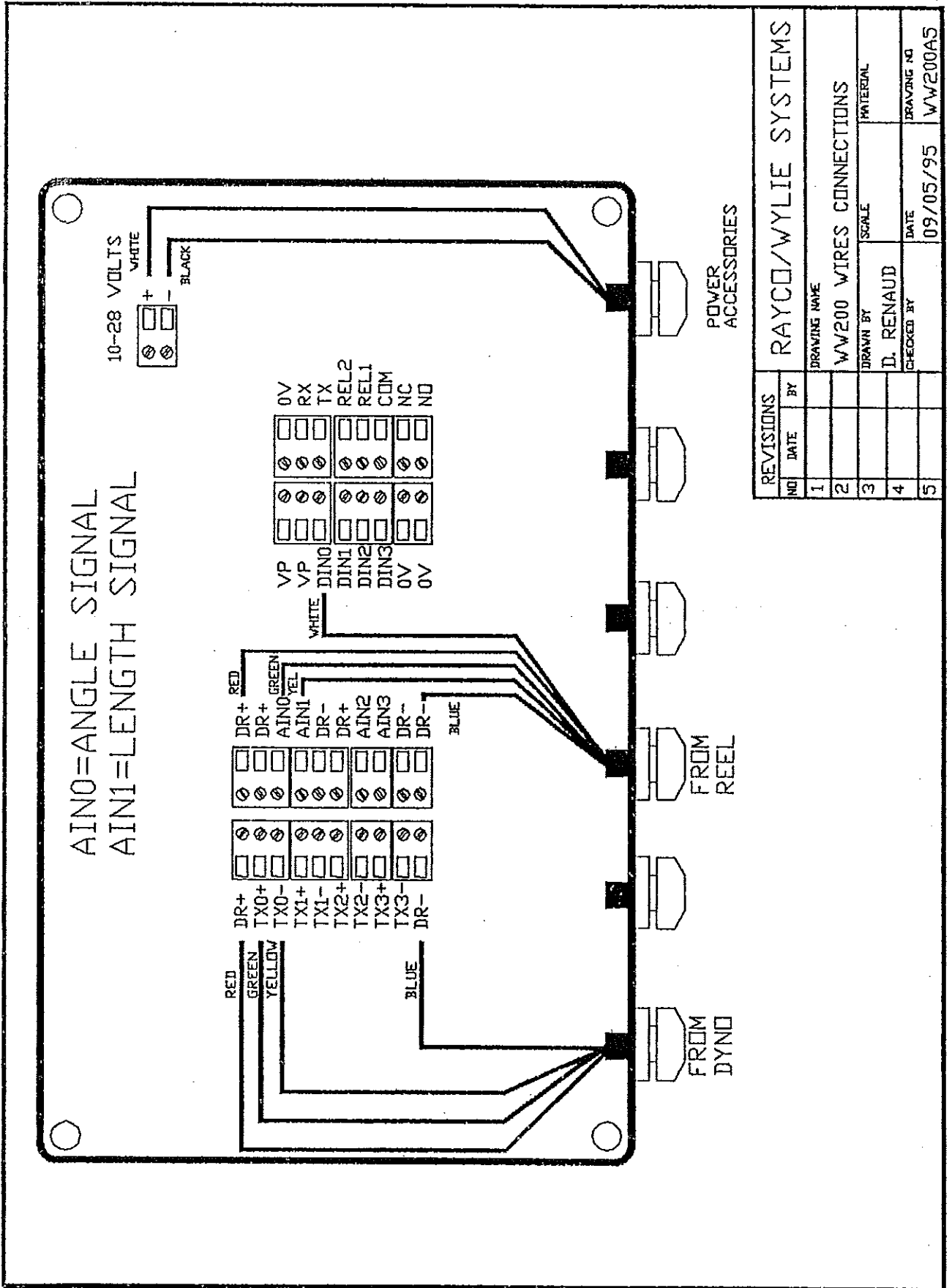





NOTE: COLOR CODE FOR ANGLE SENSOR CABLE:  
 A = RED = POSITIVE = DR+  
 B = BLUE = NEGATIVE = DR-  
 C = GREEN = SIGNAL = AINO

10-28 VOLTS

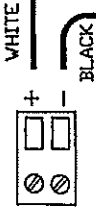

JUMPER

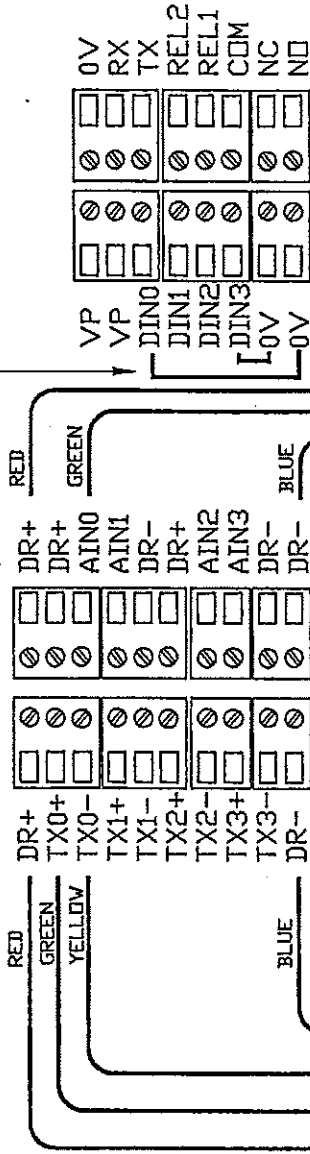

POWER SUPPLY

FROM ANGLE SENSOR

FROM DYND

REVISIONS	
NO	DATE BY
1	
2	
3	
4	
5	

DRAWING NAME	
STANDARD CONNECTION LATTICE CRANE	
DRAWN BY	SCALE
D. RENAUD	MATERIAL
CHECKED BY	DATE
	03/03/99
DRAWING NO	
WW200A1	

RAYCO/WYLIE SYSTEMS



# AINO=ANGLE SIGNAL

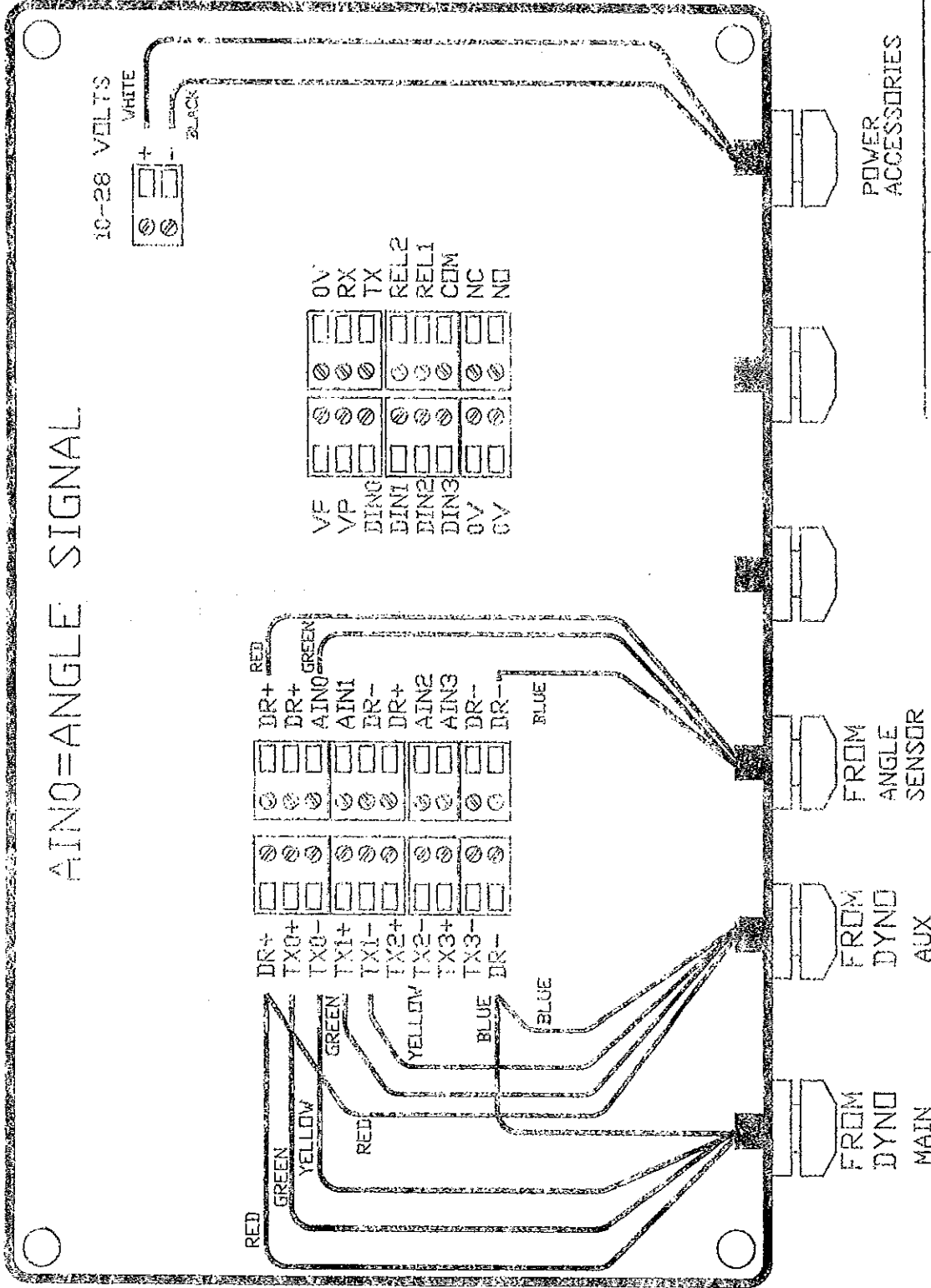

REVISIONS		DRAWING NAME	
NO.	DATE	BY	SCALE
1			
2			
3			
4			
5			

DRAWING NAME		MATERIAL	
W1250 CONNECTION MAIN & AUX			
DRAWN BY		SCALE	
D. RENAUD			
CHECKED BY		DATE	
		05-02-97	
		DRAWING NO	
		W1250A	



INSTALLATION SUGGESTION ONLY. THE PERSON WHO WILL PERFORM THE INSTALLATION IS ENTIRELY RESPONSIBLE FOR DECIDING WHETHER OR NOT THIS DRAWING APPLIES TO THE MACHINE, AND PROVIDE A SAFE LOCK-OUT FUNCTION.

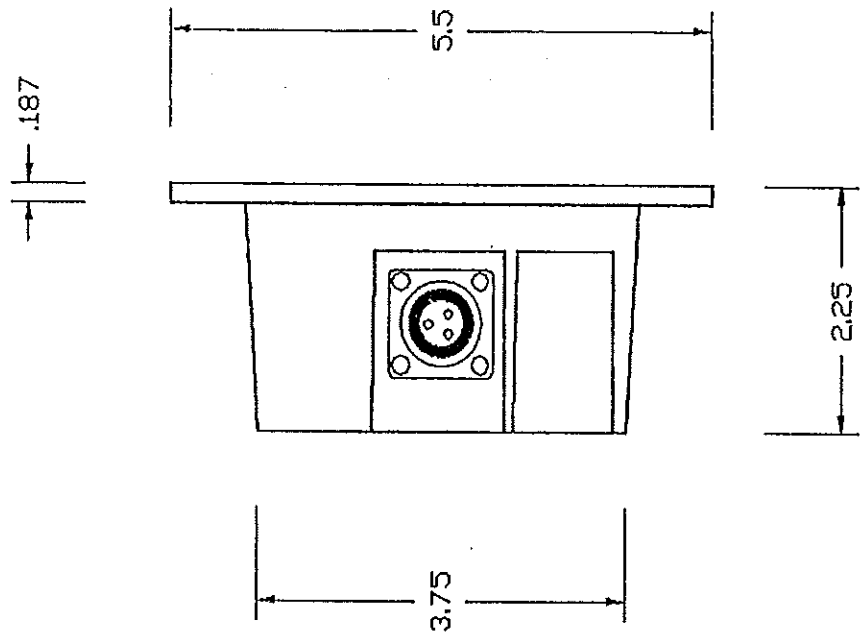
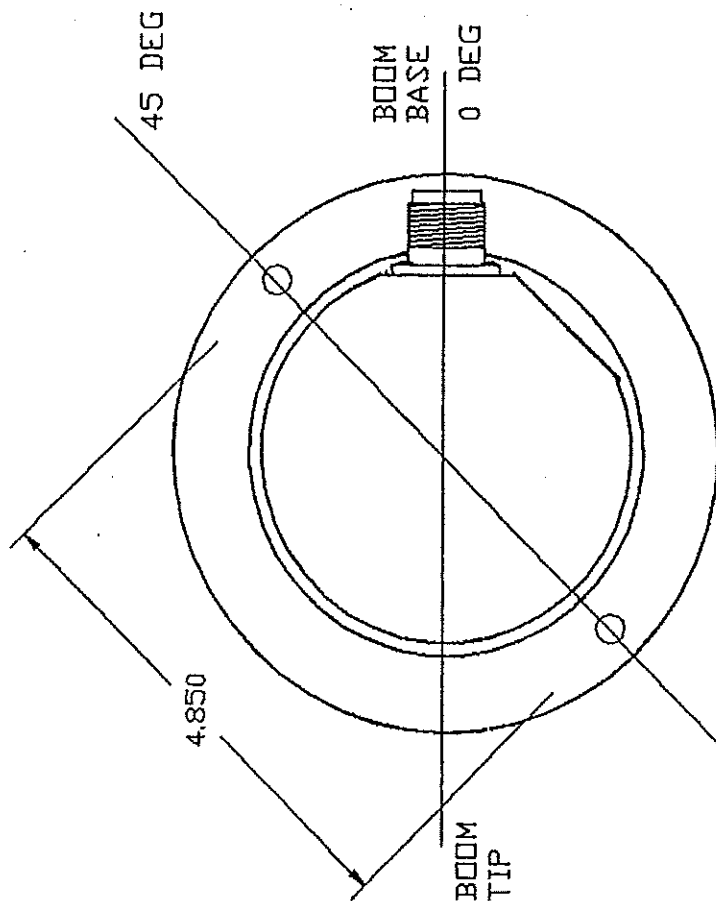

REVISIONS		RAYCO/WYLIE SYSTEMS			
NO	DATE	BY	DRAWING NAME		
1			ANGLE SENSOR SPECIFICATIONS		
2			DRAWN BY	SCALE	MATERIAL
3			D. RENAUD		
4			CHECKED BY	DATE	DRAWING NO
5				09/10/97	ZRAA1



INSTALLATION SUGGESTION ONLY. THE PERSON WHO WILL PERFORM THE INSTALLATION IS ENTIRELY RESPONSIBLE FOR DECIDING WHETHER OR NOT THIS DRAWING APPLIES TO THE MACHINE, AND PROVIDE A SAFE LOCK-OUT FUNCTION.

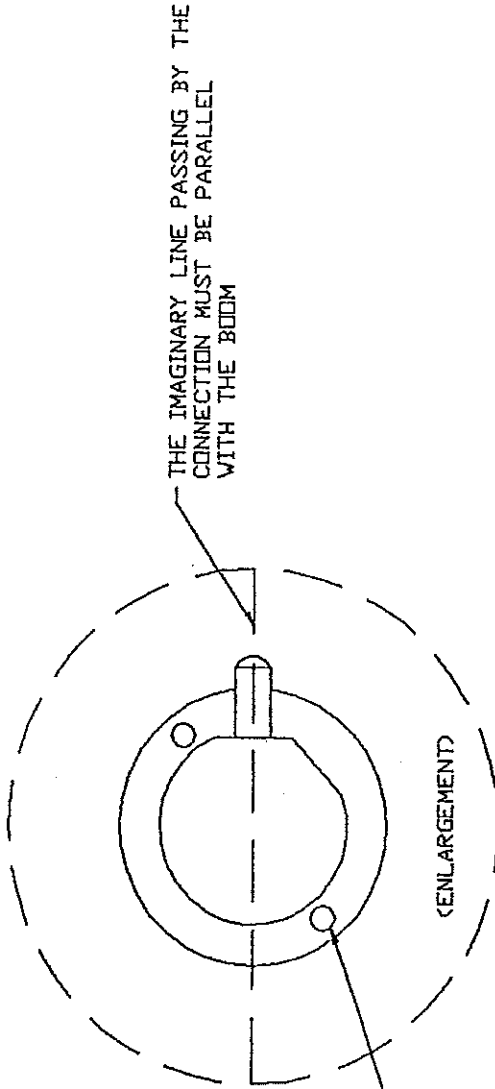

WELD THREADED SPACER ON BOOM TO SCREW ANGLE SENSOR

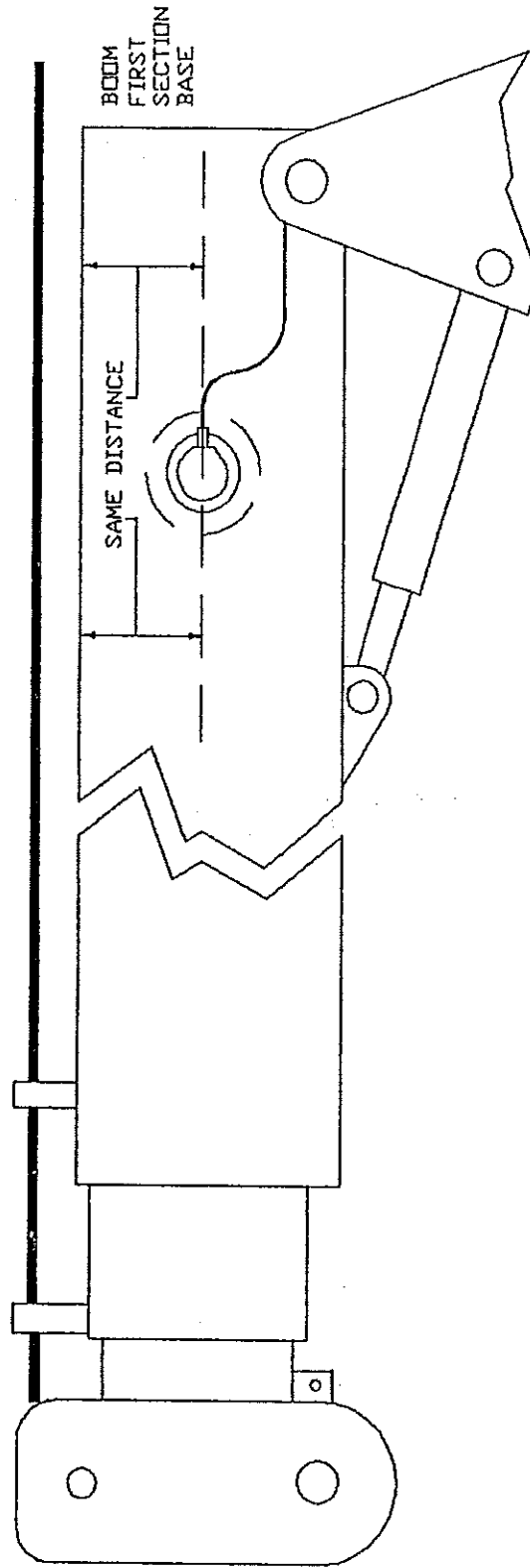

REVISIONS		RAYCO/WYLIE SYSTEMS			
NO	DATE	BY	DRAWING NAME		
1			ANGLE SENSOR INSTALLATION		
2			DRAWN BY	SCALE	MATERIAL
3			D. RENAUD		
4			CHECKED BY	DATE	DRAWING NO
5				09/10/97	DA1000





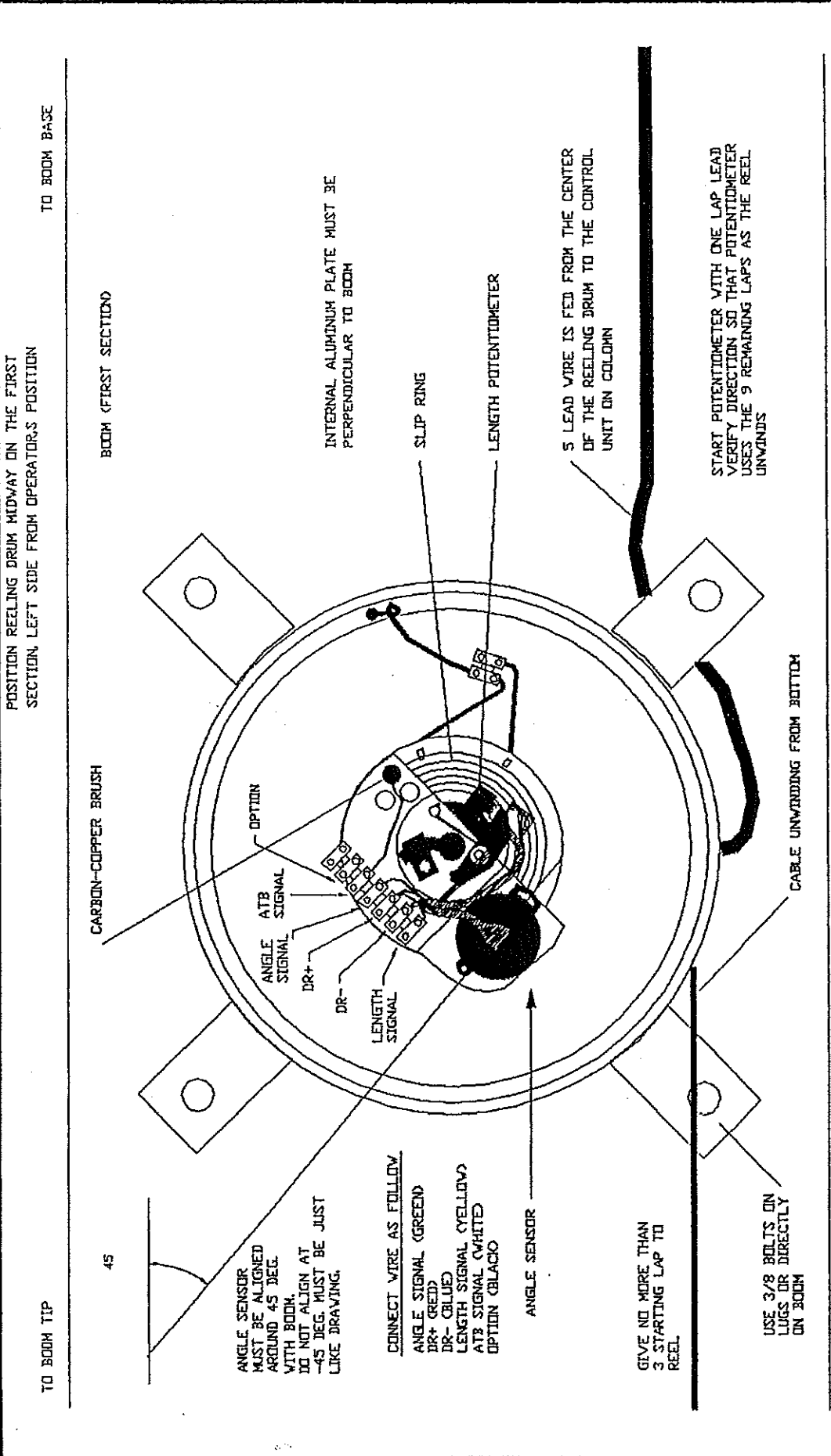

REVISIONS		RAYCO/WYLIE SYSTEMS			
NO	DATE	BY			
1			DRAWING NAME REELING DRUM MOUNTING		
2			ON HYDRAULIC CRANE		
3			DRAWN BY S. CHAYER	SCALE	MATERIAL
4			CHECKED BY	DATE 10/27/94	DRAWING NO
5					REEL 7



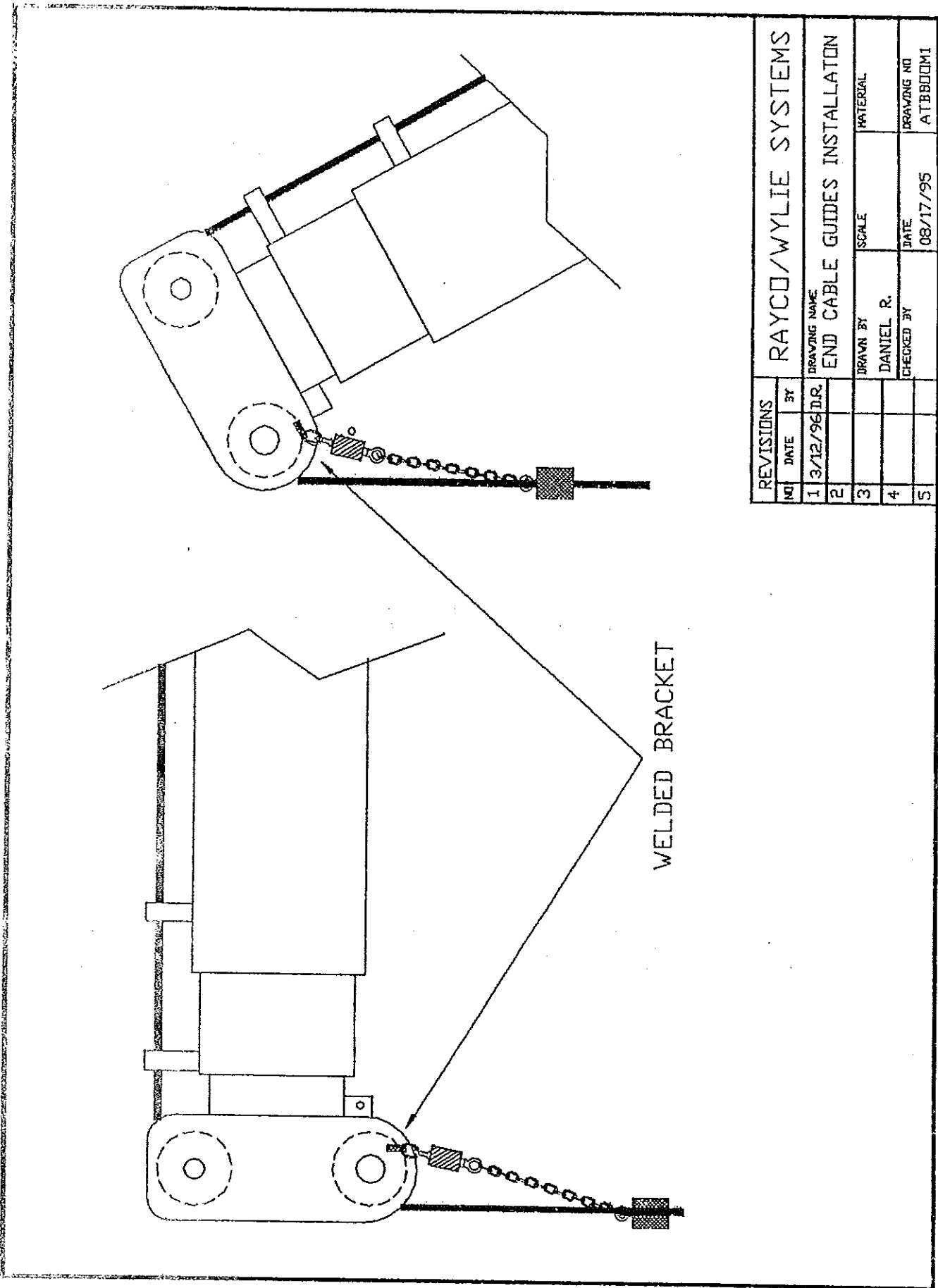

REVISIONS		RAYCO/WYLIE SYSTEMS			
NO	DATE	BY	SCALE	MATERIAL	
1	3/12/96	D.R.			
2					
3					
4					
5					

DRAWING NAME		RAYCO/WYLIE SYSTEMS	
END CABLE GUIDES INSTALLATION			
DRAWN BY	DANIEL R.	SCALE	
CHECKED BY		DATE	08/17/95
DRAWING NO	ATBDD001		



INSTALL A GUIDE AT THE END OF EACH SECTION, CUT IT TO LENGTH IN ORDER TO KEEP CABLE PARALLEL TO BOOM.

INSTALL THE FIRST GUIDE 3 TO 5 FEET AWAY FROM THE DRUM.

ON CONVENIENT SIDE OF THE BOOM, BOLT THE REELING DRUM TO THE BOOM OR STUDS. IT IS PREFERABLE THAT THE BOOM UNWINDS FROM THE BOTTOM.

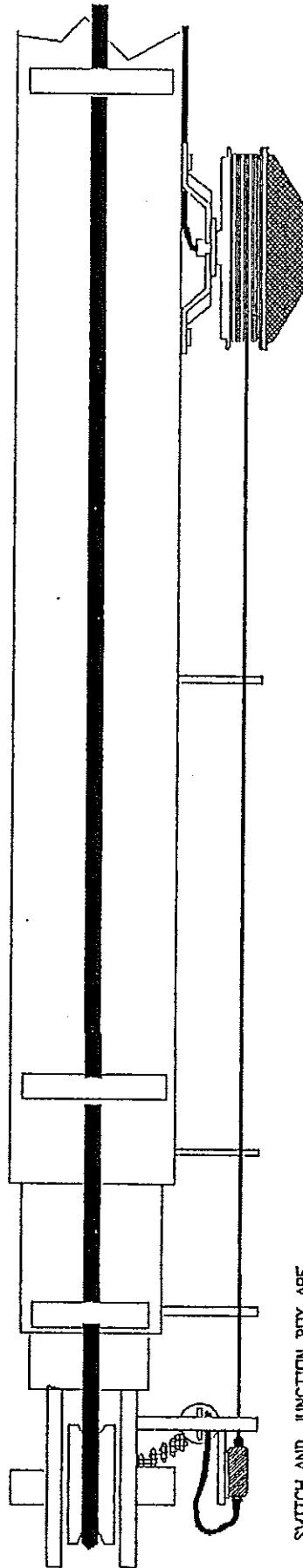

SWITCH AND JUNCTION BOX ARE FITTED ON A SPECIAL END GUIDE. PASS THE WIRE AS SEEN ON THE DRAWING.

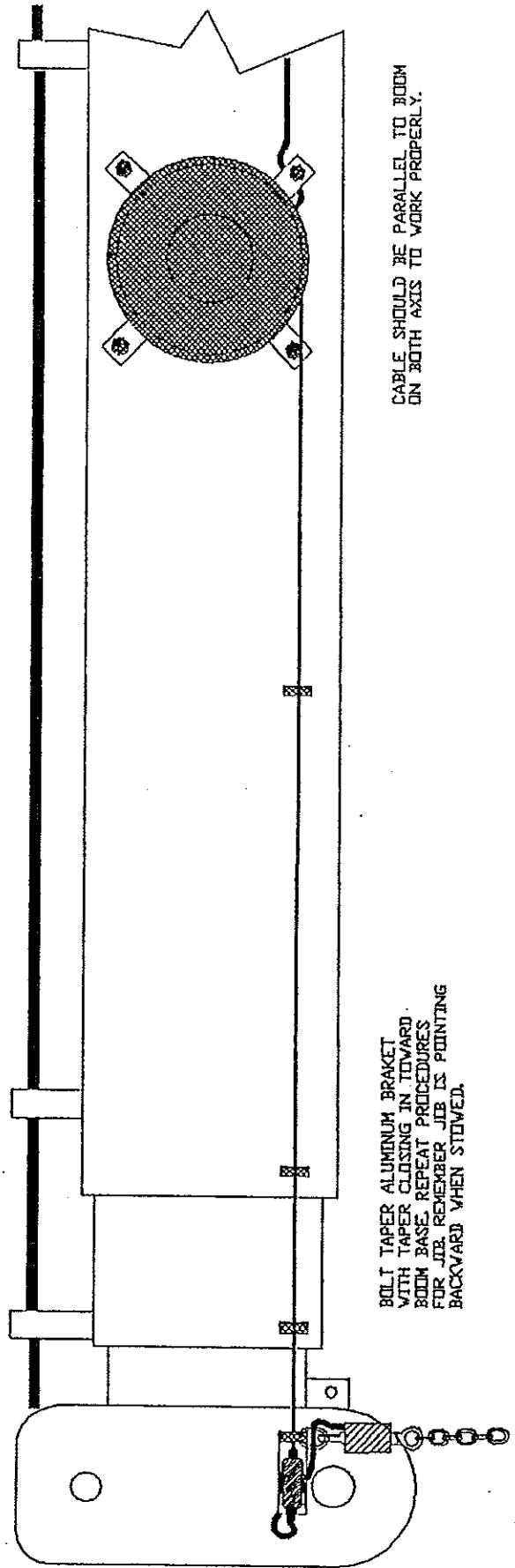

BOLT TAPER ALUMINUM BRACKET WITH TAPER CLOSING IN TOWARD BOOM BASE. REPEAT PROCEDURES FOR JOB. REMEMBER JOB IS POINTING BACKWARD WHEN STOWED.

CABLE SHOULD BE PARALLEL TO BOOM ON BOTH AXES TO WORK PROPERLY.

REELING DRUM, GUIDES, ATB SWITCHES  
INSTALLATION FOR HYDRAULIC CRANES

WYLIE / RAYCO

10/27/94 S. SCHAYER



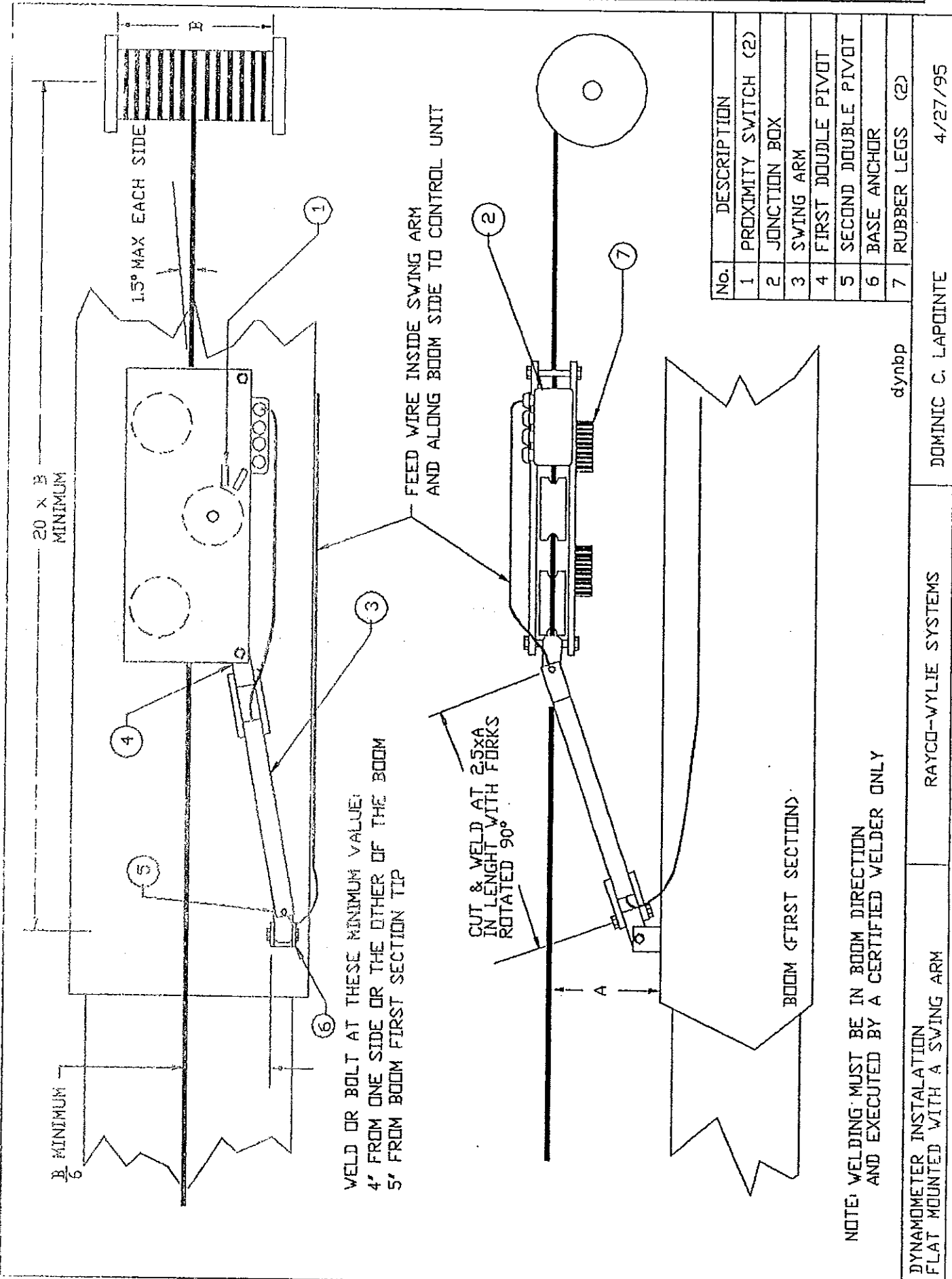





No.	DESCRIPTION
2	JUNCTION BOX
3	LUGS (4)

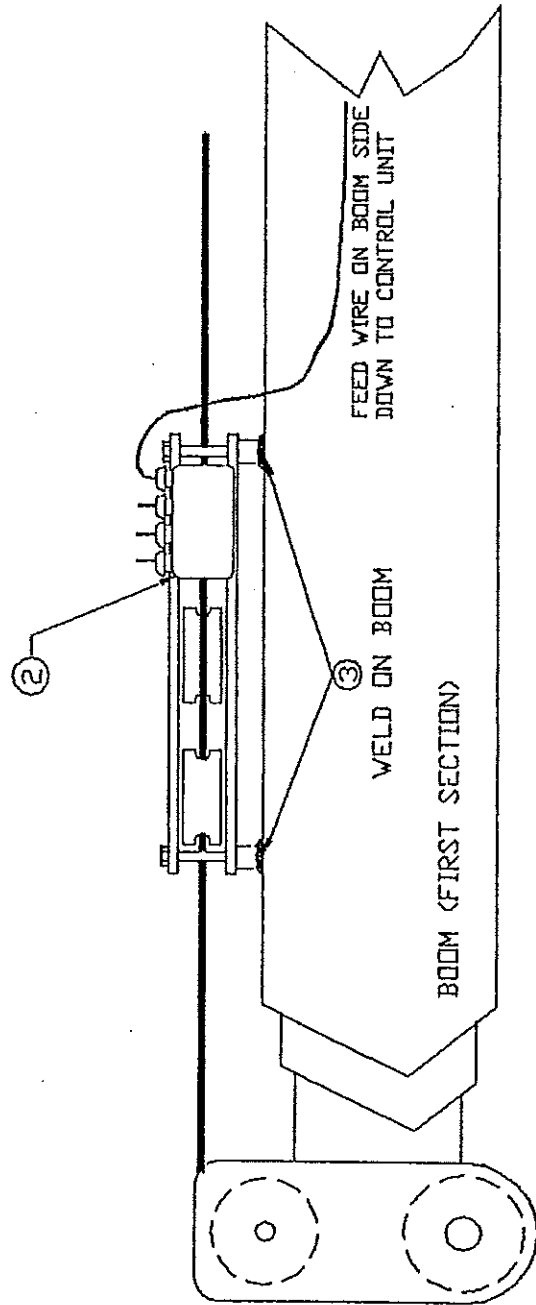
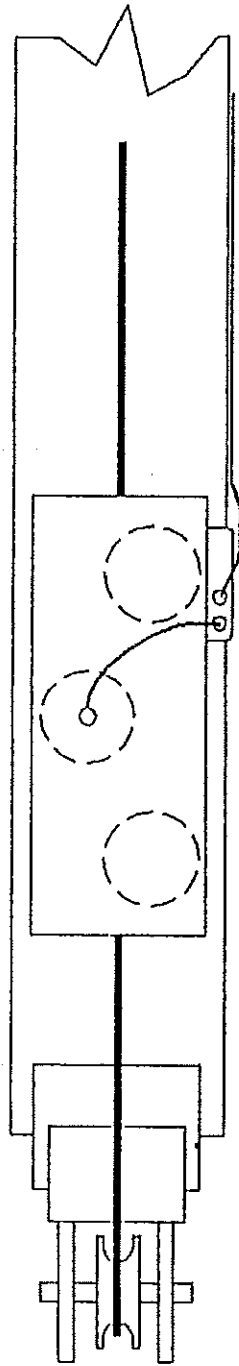

NOTE: WELDING MUST BE IN BOOM DIRECTION AND EXECUTED BY A CERTIFIED WELDER ONLY

DYNAMOMETER INSTALLATION  
FLAT AND HARD MOUNTED ON BOOM

RAYCO-WYLLIE SYSTEMS

DOMINIC C. LAPOINTE

4/27/95

dynfp



SOLENOID VALVE IS NORMALLY CLOSED AND ELECTRICALLY OPENED. FREE REVERSE FLOW (A TO B) WHEN SOLENOID IS ENERGIZED OR DE-ENERGIZED.

A AND B PORTS ARE BOTH SAE 1 (1-5/16-12)

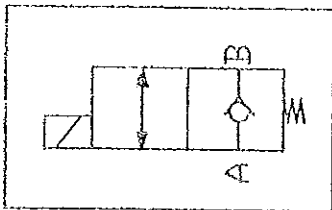

HOIST MOTOR

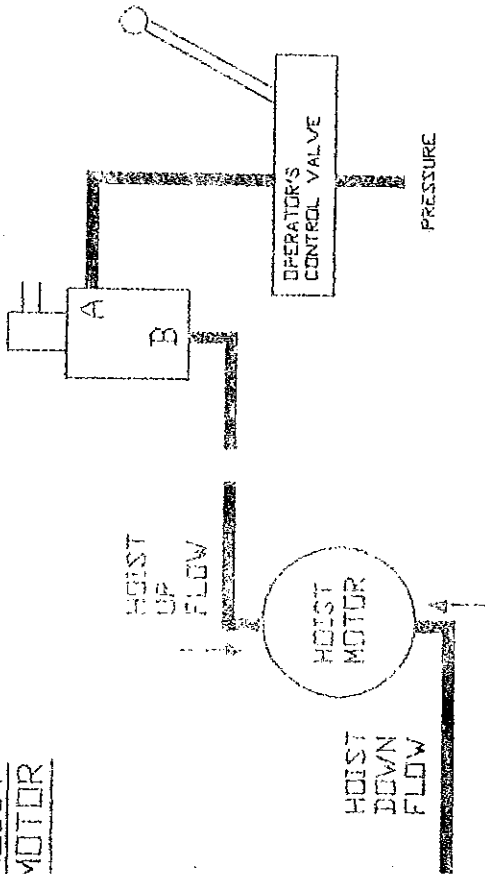

BOOM EXTEND CYLINDER

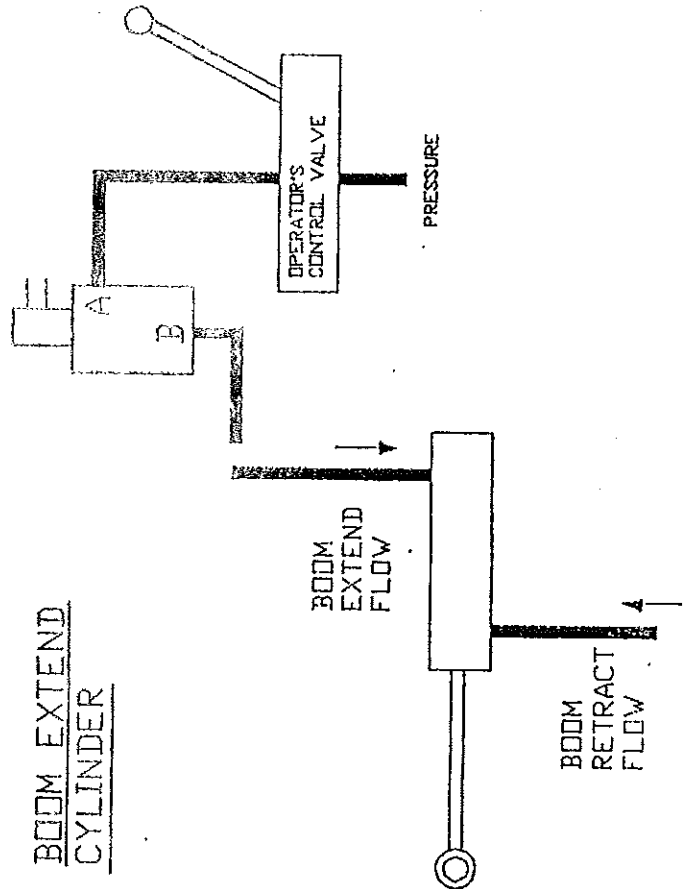

BOOM HOIST CYLINDER

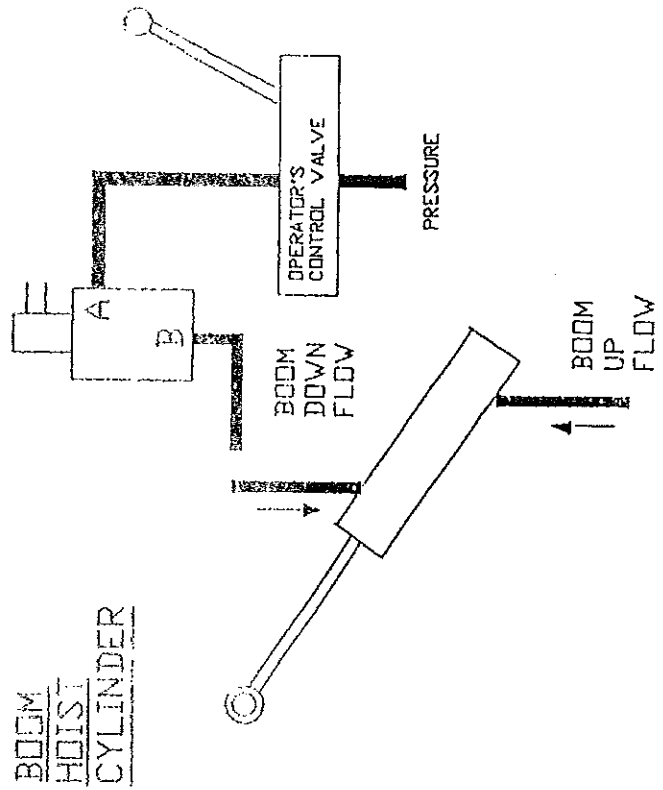



SOLENOID VALVE IS NORMALLY CLOSED AND ELECTRICALLY OPENED. FREE REVERSE FLOW (IN & OUT) WHEN SELENOID IS ENERGIZED OR DE-ENERGIZED.

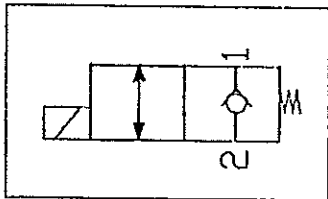

BOOM  
HOIST  
CYLINDER

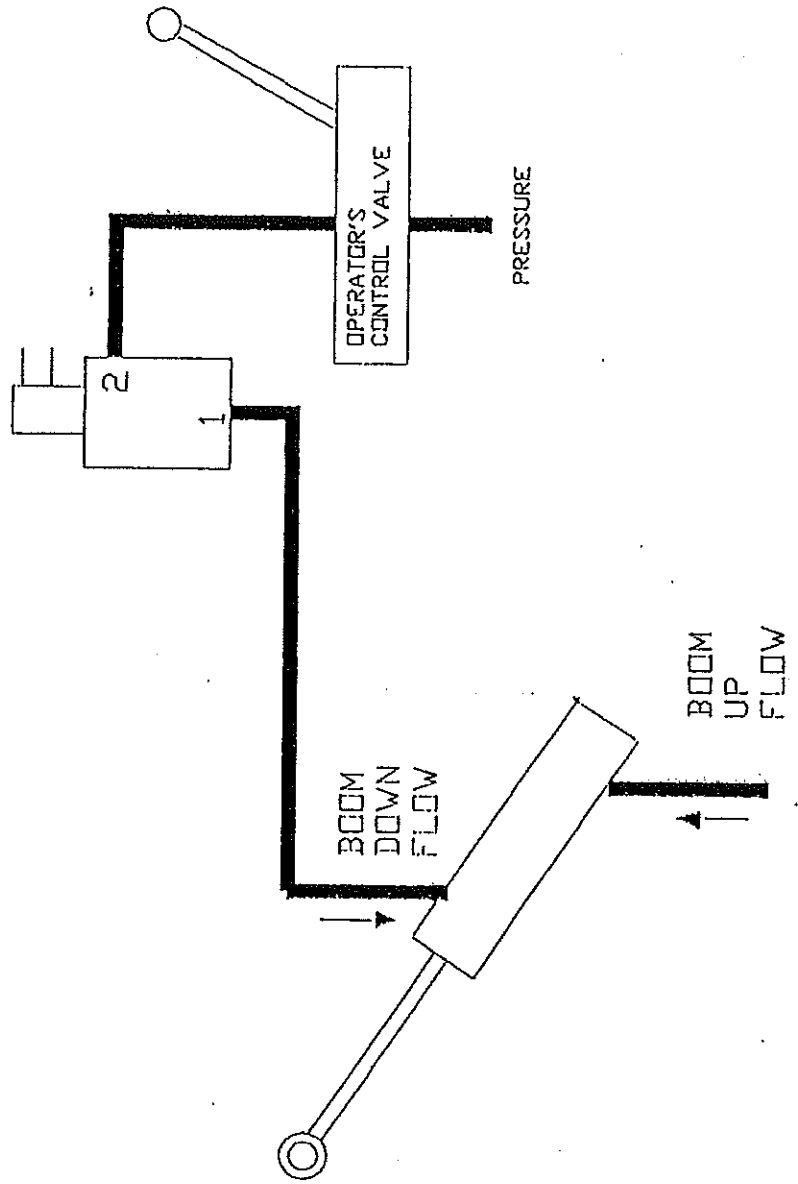





**4. CALIBRATION**

**4.1 General**

The calibration of the sensors is performed through software by entering data using the display's keypad. The only exception is manually setting the amplifier jumpers.

<p>Necessary Calibrating Tools</p>	<p>Angle indicator with accuracy of 0.5 ° or better. Steel measuring tape of 100 ft capacity with accuracy of 1' or better. Test load that produces a line pull of approximately 90% of line pull. Test load of approximately 1/10 of the above. Each test load's weight must be known accurately to within 1%.</p>
<p>Necessary Calibration Information</p>	<p>The rated line pull of each hoist. The maximum number of parts of lines. The weight of each block, slings and attachment used for calibration. The hoist line weight per feet.</p>

**4.2 Crane Preparation**

Position the crane level on firm ground. Set tires to correct pressure. Where applicable, extend outriggers. Grease all hoist systems sheaves and check for free rotation. Remove any hardened grease from sheaves.

**4.3 Indicator Preparation**

Power the unit, then select the hoist being calibrated and set the parts of lines on the display. Refer to Diagnostic mode of section 7.2. For voltages, see sensor specification sheets. Enter diagnostic mode and verify voltage input from sensors (refer to p. 6 of DIAGNOSTIC section 7.2.). If amplifiers are installed, see amplifier specification sheet.

**COMMON VOLTAGES**

For a liquid type angle sensor, boom angle (AIN0) at 0 degree should be within 1.4 and 1.9 volts, and when boomed up to 75 degrees, AINO should be between 2.6 and 3.4 volts.

For a different angle sensor, insure voltage varies at every operating angle. Minimum voltage change for all crane working range must exceed 1V (Min. acceptable = .2 volt).

For the boom length, when the boom is fully retracted, AIN1 should read between .25 and 1V. When the boom is fully extended, AIN1 should not exceed 4.75 volts. The minimum change in voltage between fully retracted and fully extended must be greater than 1 volt.

For the load sensor, with no load on the hook, AIN6 should read between .2 and 1.5 volts, and when lifting 90% of maximum line pull, AIN6 should read between 3 and 4 volts. If this is not the case, correct the internal amplifier setting described in following section 4.4 or the external amplifier setting in section 4.5. Repeat with each hoist while in the diagnostic mode. Scroll down 5 times to hoist selection. Use SET buttons to change hoist and scroll back up 5 times to AIN6. If reading remains outside of the recommended limits, a sensor may be installed or connected wrong, call for technical support.

**4.4 Internal Amplifier Setting**

To adjust the internal amplifier (used when no external amplifiers are installed), lift a load on the appropriate hoist which provides around 90% of the maximum line pull. While in the diagnostic mode, verify the voltage displayed on AIN6. Open the display box. On the



top right part of the INPUT board are the amplifier jumpers. Note the arrangement and refer to table 4.4 below to determine the amplifier level.

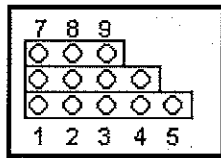

**1**

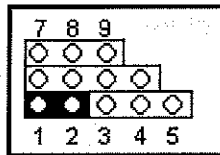

**100**

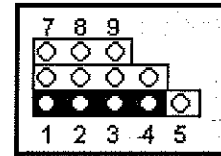

**125**

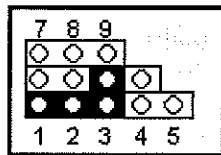

**137**

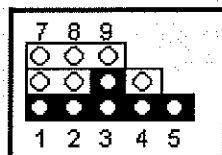

**186.5**

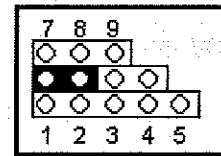

**200**

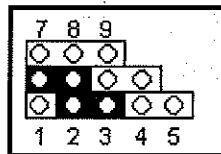

**250**

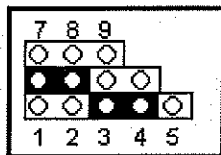

**333**

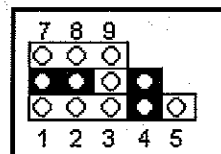

**375**

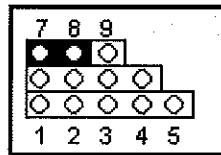

**500**

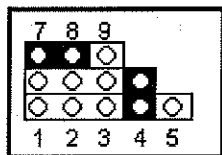

**624**

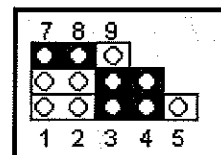

**688**

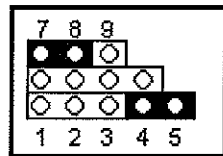

**831**

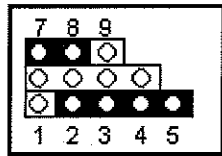

**1000**

If AIN6 is lower than 3 volts, set the jumpers to the next higher level until the voltage is above 3 volts and below 4 volts.

If AIN6 is above 4 volts, set the jumpers to the next lower level until the voltage is below 4 and above 3 volts.

100% line pull should not exceed 4.3 volts.

**4.5 External amplifier setting**

The external amplifier is usually installed on the dynamometer or on the boom nearby. There are only 4 adjustments on external amplifiers. The voltage requirements are slightly different with an external amplifier. The voltage on AIN6 must not exceed 4.3 volts with maximum line pull but remain as high as possible. Because of the few settings compared to the internal amplifier, this may be below 3 volts.

If the voltage is below 3 volts, boom down completely to access the amplifier, open the box, move the jumper to the next amplifier level. Boom back up and lift the load again. If the voltage on AIN6 is too high, boom back down and replace the jumper where it was originally.

If the voltage is above 4.3 volts with maximum line pull, boom down completely to access the amplifier, open the box, move the jumper to the next lower amplifier level. Boom back up and lift the load again. If the voltage on AIN6 is still too high, boom back down and move the jumper again.

Gain setting				<b>AMPLIFIER ZRG01</b>									
	JA	JB	JC	GAIN	Terminal J2								
1	1	1	1	2	DR-	DR+	SG+	SG-	GND.	VProx.	Prox.1	Prox.2	Direction control SW 1-7: 0 to 7F SW 8: Off = Analog level On = Analog speed
2	1	1	1	200	1	2	3	4	5	6	7	8	
2	2	1	1	250	BU	RD	GN	YE	BU	BN	BK	BK	Delay 1 <input type="checkbox"/> on 2 <input type="checkbox"/> 3 <input type="checkbox"/> 4 <input type="checkbox"/> 5 <input type="checkbox"/> 6 <input type="checkbox"/> 7 <input type="checkbox"/> 8 <input type="checkbox"/> function
2	4	1	1	274	Range: 9 Vdc to 30 Vdc (Nominal = 10 Vdc) Load DR+ Supply max.: 2 x Bridges (350 ohms) Output: 4-21 ma Load end recommended: 243 ohms								
2	4	3	3	372									
3	1	1	1	400	Terminal J1 10v 5 RD 0v 4 BU Ampl. 3 GN level speed 2 Dir. 1								
3	3	1	1	500									
3	2	1	1	666	DIVISION of <b>RAYCO TECHNOLOGY GROUP</b> Rayco electronic system Ltd.								
3	1	2	3	750									
4	1	1	1	1000									
4	1	2	2	1248									
4	4	2	2	1376									
4	1	3	3	1662									
4	3	3	3	2000									

**4.4 Calibration procedure**

A separate manual is supplied for the calibration procedure. It is recommended to have on site technical support to perform the calibration on the first few cranes.

Before entering the calibration mode, the technician should have read and fully understood this entire manual and the calibration manual.

**5. DISPLAY DESCRIPTION**

**5.1 Display Panel**

The W1250 Series, Load Moment Indicator, is a microprocessor-based system with a digital display. The main function of this system is to provide visual indications of angle, load, radius, capacity, etc. and to allow the operator to set limits on these indications.

The display panel is composed of a digital display screen, a bar graph, eight indicator lights, a sound alarm and a keypad.

**BAR GRAPH**

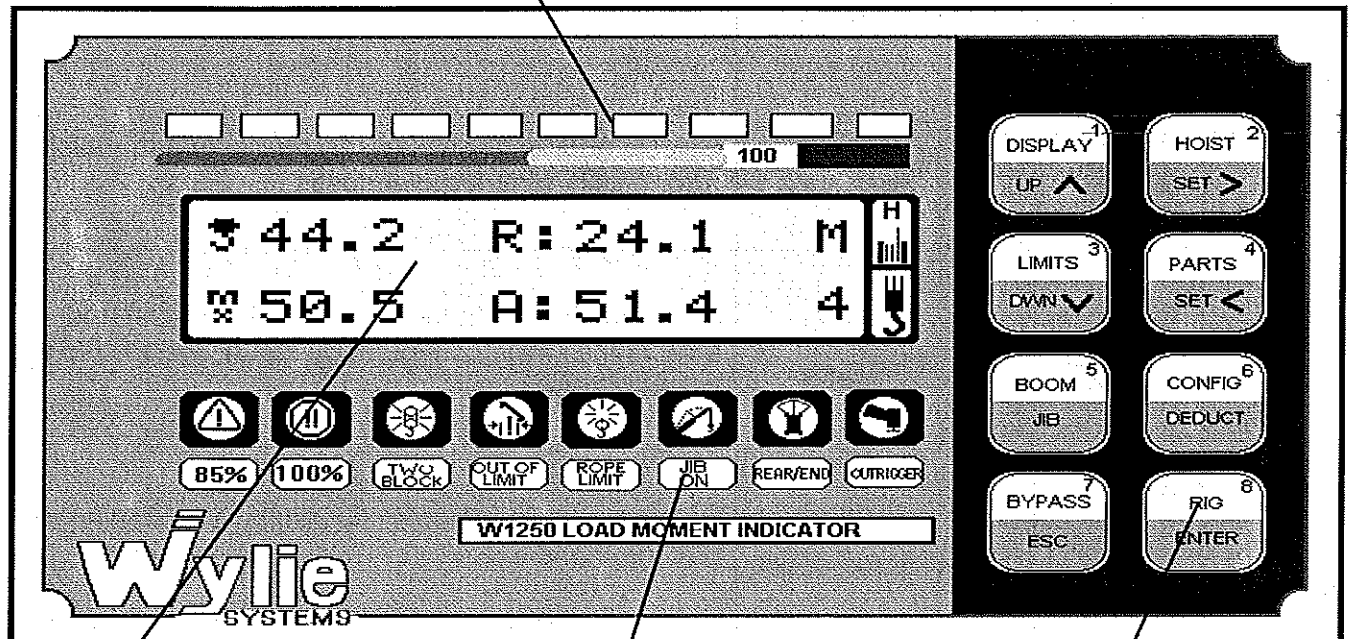

**SCREEN**

**INDICATOR LIGHTS**

**KEY BOARD**

**5.2 Bar Graph**

The bar graph is found directly above the display screen. This feature allows the operator to see the percentage of the load that is being lifted when compared to the rated capacity. As the hook load approaches the capacity more lights will illuminate.

- 0% to 84%, green range, within the set limit.
- 85% to 99%, yellow range, approaching the set limit.
- 100% to end, red range, danger, you have reached the crane's capacity.



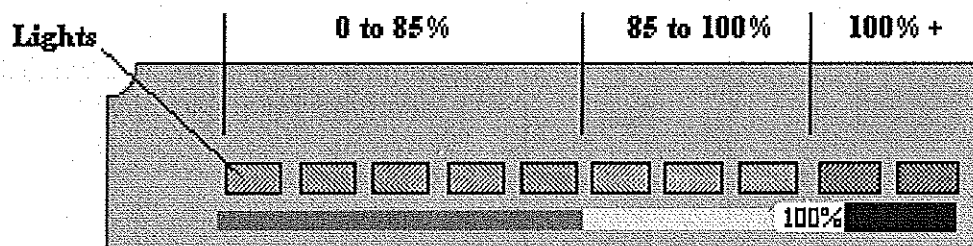



If the crane has a lockout system, it will be activated once you have reached the red light\*. However, you will be able to maneuver the crane into a safe zone by booming up, telescoping in or hoisting down.





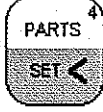





\*: Although the first red light will always come on at 100% capacity, the lockout activation may have been set at a different rating like 98% or 106%.

The bar graph light intensity can be adjusted with the Dimmer ON option of the DISPLAY button.

**5.3 Key Board**

Button	Key	Name	Description
	1	Display Scroll up	Selects additional display screen like length, height, error report, dimmer, diagnostic
	2	Hoist Set >	Pressing the button toggles to the next hoist and selects the crane configuration last associated to the selected hoist
	3	Limit Scroll down	Select the limits variables for display and setting with buttons 2 and 4
	4	Parts Set <	Pressing the button toggles to the next number of parts of lines for the selected hoist
	5	Boom Jib	Pressing this button displays the boom selection and then, automatically toggles to the next boom configuration for the selected hoist
	6	Config Deduct	Pressing this button displays alternately the selected tire/outrigger configuration and the selected deduct. Use button 2 and 4 to change them. Or, if only one field to select from, it toggles to the next selection automatically.
	7	Bypass Esc	Pressing this button bypasses the lockout momentarily. This button will bring back the main screen anytime.
	8	Rig Enter	Pressing this button below the set-rigging angle will bypass the lockout until the rigging angle is exceeded. This button confirms a new setting and return to the main menu.

**5.4 Indicator Lights**

Symbol	Warning Light Functions
	This light flashes with the audible alarm on when the load is between 85% and 99% of the rated capacity.
	This light will illuminate to warn the operator when the load is over 100% of the rated capacity. The lockout will be activated
	This light indicates two-blocking. If there is a lockout, it will be activated
	This light will illuminate when an Out of Limit condition is detected by the system. This condition occurs on a low/high angle limit, max/min length limit, max. radius limit, or a max. height limit set by the operator.
	This light indicates that the displayed maximum load is limited by the hoist Rope. Increasing the parts of line will extinguish the indicator light.
	This light indicates that a jib has been selected as the boom selection. Roosters are also considered as jibs.
	This light indicates, when an over end/rear/front duty is present, that the boom is over that section and the superior rated capacity is displayed. This light only works when a slew switch is installed.
	This light indicates outriggers fully extended and down have been selected in the configuration by the operator.

**5.5 LCD Screen**

PRIMARY SCREEN:

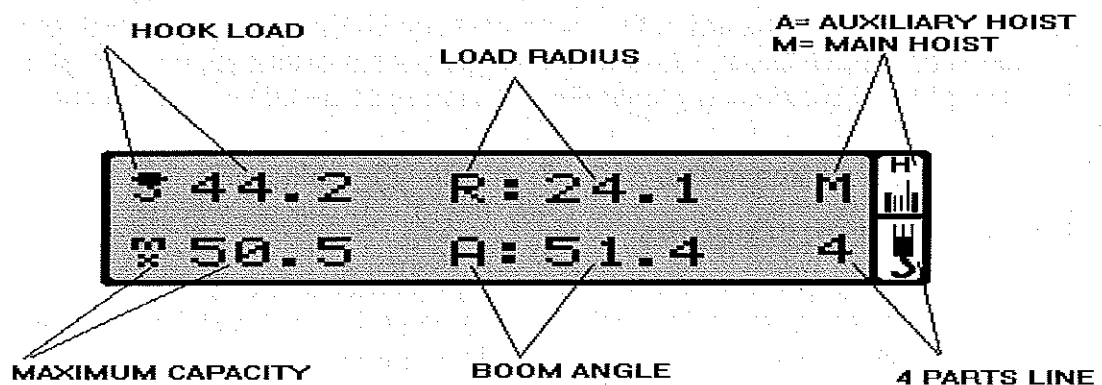

When the power is turned on, the system automatically defaults to this screen after showing the company name and the units of display.

The system will always return to this screen if no buttons are pressed or if the system is left alone for 10 seconds.

This screen can also be accessed at any time while in any other function by pressing the ESC button once or twice.

## 6. OPERATING INSTRUCTION

When the power is turned on, the system briefly shows the company name, then for three seconds, it displays the measuring units, and then; it goes into the normal operating mode. As shown above, the normal mode displays the hook load, the rated capacity, the radius, the angle, the hoist used and the parts of lines.

### 6.1 **\*\*\* Warning \*\*\***

The Wylie Load Moment Indicator is to be regarded only as an aid to the operator. When the parameters are set correctly, the indicator will warn the crane operator of an approaching overload condition that could cause damage to equipment, property, and/or injury to the operator or site workers in the vicinity of the crane and its load.

This system must never be used, under any circumstances, as a substitute for the good judgment of a crane operator when carrying out approved crane-operating procedures. Responsibility for the safe operation of the crane lies with the crane operator. The indicator equipment will not necessarily prevent crane damage due to overloading and related causes if not set properly.

The safe operation of the crane is the sole responsibility of the operator who must observe and obey all warnings and instructions supplied by Wylie, the crane manufacturer, and the relevant Safety Authorities. This system complies with the SAE J375, SAE J159, SAE J374.

During normal operation the SWL (safe working load) of a crane must not be exceeded. It should be noted that certain statutory requirements do not permit the SWL to be exceeded except for the purpose of testing.

Before operating a crane equipped with a Wylie system, the operator must carefully read the information in both this manual and the crane manufacturer operator's manual to ensure that he/she fully understands the correct operating procedures and safety standards.

Correct functioning of the system depends upon routine daily inspection. Any suspected faults or apparent damage should be immediately reported to the responsible authority before using the crane.

The W1250 must be set to the crane parameters E.G.[outriggers, tires 360, tire front, pick and carry, main boom, rooster, jib 33 ft, power pin extended, main hoist, auxiliary hoist and parts of lines] before operating the crane or when changing the parameters.

The Load Moment Indicator, W1250 Series, is not suitable for use in a hazardous (Explosive) environment.

### 6.2 **Operating procedures**

In order to have the proper rated capacity and radius, the system must be configured properly. Failure to configure the system properly can cause the crane to break or tip and result in injury or death. Failure to configure properly may also cause a zero capacity if no chart is found to match the configuration set by the operator. E.G.: On tire 360 with a jib 33 ft may not have a charts.

The operator must verify the crane configurations for each available hoist every time he enters the crane and every time the crane is rigged. The following are examples which requires the operator to reconfigure the system:

**MAIN HOIST:**

- Parts of lines
- Lifting over main boom
- Lifting over a rooster
- Lifting with power pin extended
- Lifting with a jib
- Lifting on outriggers
- Lifting on tires 360
- Lifting on tires over front
- Pick and carry
- Deducting the other block weight
- Deducting for the rooster
- Deducting for the stowed jib
- Deducting for the erected jib

**AUXILIARY HOIST:**

- Parts of lines
- Lifting over main boom
- Lifting over a rooster
- Lifting with power pin extended
- Lifting with a jib
- Lifting on outriggers
- Lifting on tires 360
- Lifting on tires over front
- Pick and carry
- Deducting the other block weight
- Deducting for the rooster
- Deducting for the stowed jib
- Deducting for the erected jib

Each hoist has its own configuration set-up in memory. Simply by changing the hoist from main to auxiliary, the configuration and number of parts of lines will change. Therefore, the operator must select each hoist and verify the configurations and number of parts of lines.

These 4 buttons can access configuration: **HOIST, PARTS, BOOM, CONFIG/DEDUCT**.

Operator can also set operating limits like maximum angle, minimum angle, maximum radius, etc. These limits are permanent. Operator can access them with the **DISPLAY** button and change them with the **SET** buttons.

Operator can temporarily view the boom length and height by using the **DISPLAY** button.

Operator can override the lockout system in the event of an emergency, if enabled, by pressing the **BYPASS** button.

Operator can override the lockout while rigging, if enabled, by pressing the **RIG** button.

The system will not indicate or account for unusual, not permitted and dangerous maneuvers. Nor will the system compensate for side load and off level situation.

### 6.3 DISPLAY button



Every time, the button is pressed, an additional screen appears. If no buttons are pressed for 10 seconds, the primary screen will reappear.

From the primary screen, press the **DISPLAY** button once:



LENGTH AND HEIGHT

On this screen, the operator can view the boom length and the boom head sheave height to the ground. The hook load and the radius are still displayed on the bottom line. Wait 10 seconds or press **ESC** to return to the primary screen.

From the primary screen, press the **DISPLAY** button twice:



ERROR REPORT

On this screen are shown the errors codes: a letter represents each error. See the trouble section for the description of the error codes. The error codes below are likely to be encountered by the operator:

**S** Failure - No duty Chart

This failure will occur when an operator has selected accidentally a crane configuration for which there is no chart E.G: JIB 32 ft and ON RUBBER TIRES. To correct the situation, Press ESC and then press either the BOOM-JIB button or the CONFIG-DEDUCT button and select a crane configuration for which there is a chart.

In some cases, no duty is found because of the rotation switch if installed, E.G: Main boom over the side of the crane with a PICK AND CARRY configuration. To remedy, swing over the rear of the crane.

**T** Configuration not Calibrated:

When this error shows up, it means that the specific jib configuration was never calibrated on the radius. The radius must be calibrated in order to remove the error message and obtain the capacity chart, even if the chart is based on angle.

If one jib configuration is not calibrated, it does not impair the calibrated ones. It is possible for the first jib to be calibrated with the manual section extended but not calibrated with the manual retracted.

From the primary screen, press the **DISPLAY** button three times:



DIMMER OFF

The dimmer control controls the intensity of the display lights. When OFF, the display lights have full intensity, when ON, the display lights have half the intensity. Press the **SET>** to change. This option is useful when working at night.

From the primary screen, press the **DISPLAY** button four times:

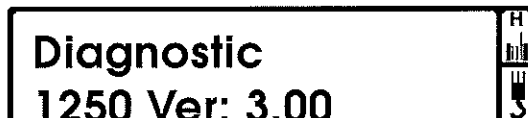

DIAGNOSTIC MODE



This is an access gate for the diagnostic menu. To access the diagnostic menu, simply press **ENTER**. To exit the diagnostic menu at any time, press **ESC** twice.

For more details about the diagnostic menu, see DIAGNOSTIC MODE in the TROUBLE SHOOTING section.

**6.4 LIMITS Button**

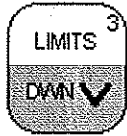

By pressing this button, the operator can access the limit setting menu. The operator will be able to view and change limits on angle high, angle low, minimum length, maximum length, maximum radius and maximum height.

To access the limits, press the LIMITS button until the desired limit appears. To change the limit press the SET button #2 or the SET button #4. To return to the main menu, press **ESC** or **ENTER**.

The operator does not need to confirm a change of limit. Once the value on the display is changed, the limit is changed. The limit is permanent. Even if the system is turned off, the limits are kept in memory.

The boom can be at any position when setting a limit. If the operator changes a limit, but he does not press **ESC** or **ENTER**; the system will return to the primary display and the limit will be recorded. Press **LIMITS** once, use **SET>** or **SET<** to set and **ESC** to exit:



Press **LIMITS** twice, use **SET>** or **SET<** to set and **ESC** to exit:

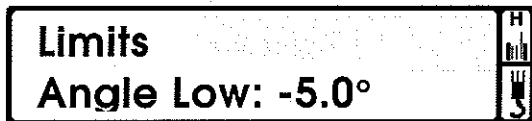

Press **LIMITS** three times, use **SET>** or **SET<** to set and **ESC** to exit:

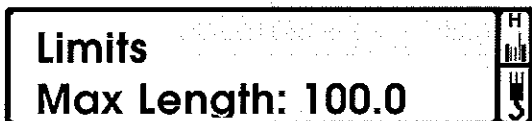

Press **LIMITS** four times, use **SET>** or **SET<** to set and **ESC** to exit:

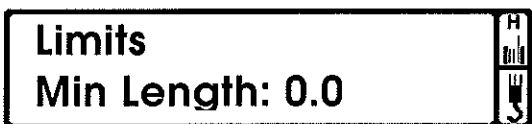

Press **LIMITS** five times, use **SET>** or **SET<** to set and **ESC** to exit:

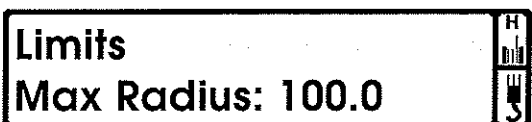

Press **LIMITS** six times, use **SET>** or **SET<** to set and **ESC** to exit:



**6.5 HOIST Selection**

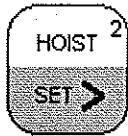

This button allows the operator to select the hoist used. The operator can see the hoist selected on the top right part of the display. **M** stands for main hoist. **A** stands for auxiliary hoist. **W** stands for whip line and **4** stands for fourth hoist.

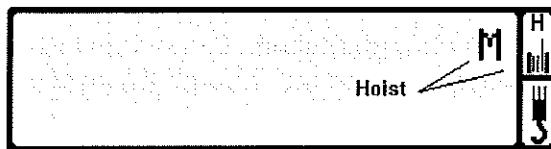

When pressing the **HOIST** button, the system selects the next hoist. Only the hoist programmed will appear on the display. For instance, if a crane has a main and an auxiliary hoist. Pressing the **HOIST** button will switch from **M** to **A** and from **A** to **M**. Note, the number of parts of lines, the boom selection and the crane configuration are associated with each hoist. Therefore, by changing to a different hoist, all associated settings for the hoist are changed automatically.

Example:

Main Hoist	Auxiliary Hoist
4 parts of lines	1 part line
Lifting over main boom	Lifting over jib 33ft
On tires 360 degrees	On outriggers
Deduction for the erected jib 33ft + the rooster + the 10 ton ball	Deduction for 3 sheave block + the rooster

Always verify the configurations after changing to a different hoist. See following sections for parts of line, boom-jib selection and configuration-deducts selection.

**6.6 PARTS OF LINES Button**

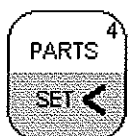

The parts of line set for the selected hoist are shown on the lower right corner of the display screen.

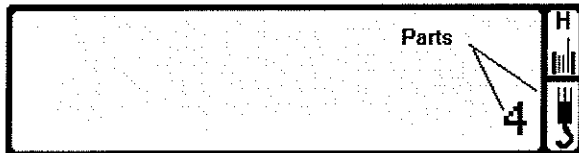

To change, simply press the **PARTS** button. The number of parts of lines will increase until the maximum number available on the crane is reached and then return to one, two, three, etc.

The number displayed is automatically set. There is no need to press other buttons. Note, if the hoist is changed, the number of parts of lines will also change.

**6.7 BOOM / JIB Button**

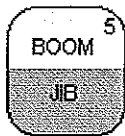

By pressing the button **BOOM / JIB** once. The display screen will display the current boom-jib selection without changing it. Example: Over main boom.



By pressing the same button additional times, the indicator will select and display the various boom selections available. Once displayed, the selection is automatically set. The operator can press either button number 7 (**ESC**) or button number 8 (**ENTER**) to return to the primary display screen. If the operator does not touch any buttons for 10 seconds, the display automatically returns to the primary screen and the boom selection last displayed is selected.



The boom selection consists of the main boom, the rooster, the manual or power pin extension, the jibs and the jib angles. When setting a boom-jib selection, the system will select the appropriate chart and the radius calibration.

**6.8 CONFIG / DEDUCT (One Selection)**

**6.8.1 One Selection Rough Terrain**



When pressed once, this button allows viewing of the selected tire/outrigger configuration or the capacity deduction selected without changing it. Example: ON OUTRIGGERS.

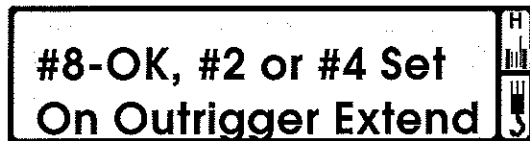

By pressing the **CONFIG** button additional times, the indicator will select and display the various selections available. Once displayed, the selection is automatically set. The operator can press either button number 7 (**ESC**) or button number 8 (**ENTER**) to return to the primary display screen. If the operator does not touch any buttons for 10 seconds, the display automatically returns to the primary screen and the selection last displayed is selected. Example:

ROUGH TERRAIN, YARD OR CARRYDECK CRANES

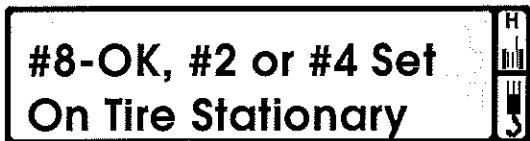
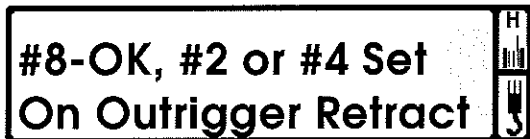
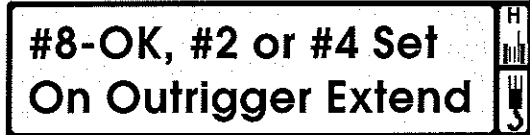

**6.8.2 One Selection Boom Truck**



When pressed once, this button allows viewing of the selected tire/outrigger configuration or the capacity deduction selected without changing it. Example: DEDUCT STOWED JIB.

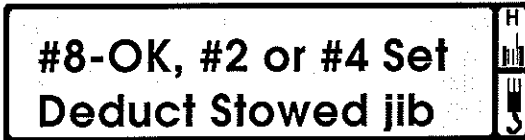

By pressing the **CONFIG** button additional times, the indicator will select and display the various selections available. Once displayed, the selection is automatically set. The operator can press either button number 7 (**ESC**) or button number 8 (**ENTER**) to return to the primary display screen. If the operator does not touch any buttons for 10 seconds, the display automatically returns to the primary screen and the selection last displayed is selected. Example:

**BOOM TRUCK**

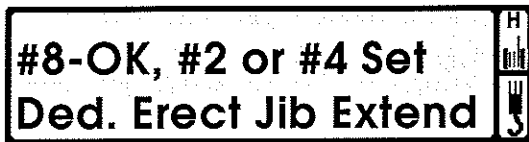
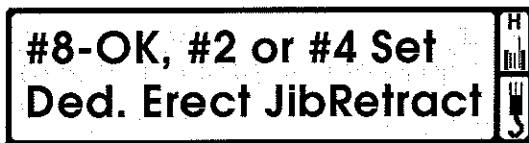
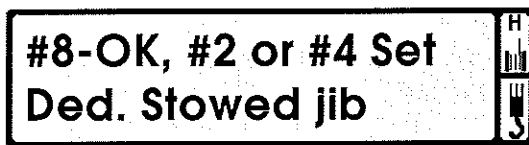

**6.9 CONFIG / DEDUCT: (Multiple Selections Only)**

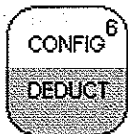

When pressed, this button allows viewing of the selected tire/outrigger configuration, the deductions for blocks and jibs, the type of counterweight and any other selection the operator must make to obtain the proper chart. The operator can press this button as many time as he wants since the information shown on the screen rolls. Example:

Just using the **CONFIG/DEDUCT** button the operator can view various selected configurations and deducts as follows:

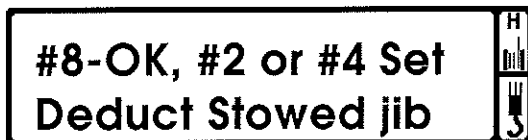
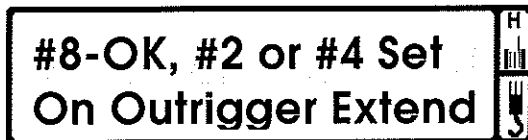

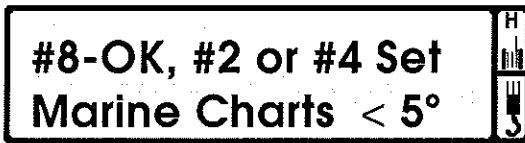
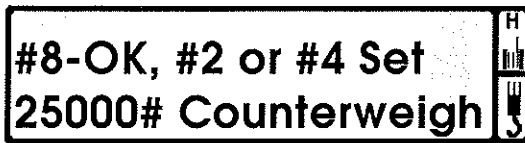

To change any of the displayed selections, the operator must use button **SET>** and button **SET<** as shown on the screen. When the desired selection is displayed, the operator can continue pressing the **CONFIG/DEDUCT** button to verify the other selections or press **ESC** or **ENTER** to return to the operating (primary) display.

If the operator does not press any buttons for 10 seconds, the system returns to the operating display and all the changes made are still in effect.

Each selection consists of a common topic. For example, the first selection may show: ON OUTRIGGER EXTEND. By using the **SET** buttons, the operator could select ON OUTRIGGER RETRACT or ON RUBBER TIRE or ON RUBBER CREEP, etc. The system will instantly select the appropriate chart and display the new capacity.

If the next selection shows: NO DEDUCT, by using the **SET** buttons, the operator may be able to select DEDUCT STOWED 32FT JIB or DEDUCT ERECTED 32FT JIB, etc. Note that deductions usually include the weight of the ball when a jib is mentioned. For instance, if the deduction for an erected jib is 3000 lbs and the ball 200 lbs; a DEDUCT ERECTED 32FT JIB will subtract from the main boom capacity 3200 lbs.

If the next selection shows: 25000# COUNTERWEIGHT, by using the **SET** buttons, the operator can select 15000# COUNTERWEIGHT or NO COUNTERWEIGHT, etc.

If the next selection shows: MARINE < 5°, by using the **SET** buttons, the operator can select LAND CHARTS or MARINE < 2°, etc.

The operator can continue verifying the various other selections available by pressing the **CONFIG** button or exit and return to the main menu by pressing **ESC** or **ENTER**.

**6.10 BYPASS Button**



If a lockout or an external alarm is installed, it can be bypassed or overridden by pressing the button number 7 (**BYPASS**). This is momentary and the bypass will work only while the operator presses the button.

This function may be deactivated / activated by a key if requested by the customer. If a key is installed, the key needs to be in position in order to activate the **BYPASS** button.

**6.11 RIG Button**



If a lockout or an external alarm is installed, it can be bypassed or overridden permanently while rigging the crane. To function, the boom must be below the pre-calibrated rig angle E.G.: 10 degrees. Below this angle, the operator can press the **RIG** button and the message **RIG** and the threshold angle will appear on the screen. The message and the lockout bypassed will remain until the boom has passed the rig angle or the system turned off. The rig mode will bypass the internal alarm.

The rig mode may be at a different angle or absent on the system depending on the customer's request.

**6.12 Quick Tricks**

There are two quick tricks that may be useful to know.

**QUICK RESET**

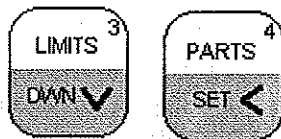

Press simultaneously the **LIMITS** and **PARTS** buttons. The system automatically resets. This trick can be used anywhere in the normal mode or in the calibration mode.

**SPEED SETTING**

When changing a value with the set buttons like a limit for instance, it may take a while to go from 20.7 feet to 150.3 feet in increments of 0.1 foot. While pressing on the **SET** button, use a finger from the other hand and press on the **ENTER** button. The value now increments in feet instead of tenths of feet. Release the **ENTER** button while still pressing on the **SET** button and the increments return to tenths of feet. Do not release the **SET** button before the **ENTER** button or the value will be entered instantly.

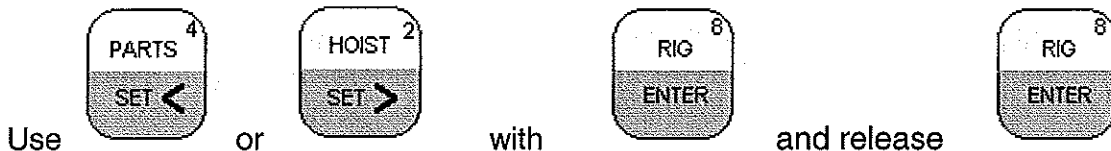

**7. QUICK REFERENCE SHEET**

With this manual you will find the laminated sheets that apply to your system. We strongly recommend that they be installed in the cab for they were designed as an aid for new

operators as well as a refresher for experienced operators. We suggest as well that a company decal be placed on the sheets with the name and phone number of the person responsible for the system. It is important for operators, especially in the case of bare rentals, to be able to get the support needed in order to ensure proper use of both the crane and the system.

## 8. TROUBLE SHOOTING

If the alarm sounds, it is caused by an overload, a sensor failure or an operator adjustable limit exceeded. If an operator adjustable limit is exceeded, it will be displayed on the screen, See limit setting section of the manual.

The first step is to verify if the alarm is caused by an overload. Verify the hook load and the capacity, if the crane is overloading, lower the load or reduce the radius. If the alarm still sounds, go to the next step.

The second step is to verify the hoist selection, the parts of lines, the boom/jib selection and the configurations/deductions. Verify that the capacity showing on the bottom left of the display matches with the capacity according to the load chart. All must be right. If the alarm still sounds, go to the next step.

The third step is to access the W1250 System error menu and diagnostic menu. To access the error menu, press the **DISPLAY** button twice. The letters on the lower line of the display are error codes. See error code section of this manual.

### 8.1 Error Code

While in the normal operation mode, press button number 1 (**DISPLAY**) two times. The display will show ERROR REPORT. The second line will be either NO ERROR or letters. If a letter is shown, there is an error or a failure. See table below for a description of the error.



This screen indicates that there are no errors. However, if an error exists in your system, you would have a list of codes and not the «No Errors» message. Take note of the Error codes. Below is a listing of the codes with their respective definition.

	DEFINITION	CODE
Failure due to sensor	A	Failure in sensor TX0
	B	Failure in sensor TX1
	C	Failure in sensor TX2
	D	Failure in sensor TX3
	E	Failure in sensor AIN0
	F	Failure in sensor AIN1



	G	Failure in sensor AIN2
	H	Failure in sensor AIN3
Failure due to Board (I/O)	I	Failure due to low battery
	J	Failure in DR Plus
	K	Failure in HIS Time-out
Failure due to Display	L	Failure with keypad
	M	Failure with LCD display
	N	Failure in 8255 chip
Failure due to Memory	O	Failure - Eprom busy
	P	Failure - Checksum Eprom
	Q	Failure - Checksum EEprom
	R	Failure - Checksum RAM
Failure due to chart	S	Failure - No duty Chart
	T	Configuration not calibrated
	U	Failure - Checksum Chart
	V	Failure - Invalid value detected
	W	Dimension missing

**ERRORS FROM A TO H**

Errors from A to H are caused by sensors, this means that the sensor is either faulty, out of the operating parameters, not connected or not calibrated. Use the diagnostic menu to see the input voltage from the sensor. See sensor specification sheet at the end of this manual for voltage and working parameters. Note if an amplifier is installed because of slip rings or distance, see amplifier specification and use the sensor specification for the amplifier-input specification.

Following is a description table of the sensors:

TX0	Load sensor on Main hoist line	Also referred to as AIN6
TX1	Load sensor on Aux hoist line	Also referred to as AIN6
TX2	Load sensor on Whip1 hoist line	Also referred to as AIN6
TX3	Load sensor on Whip2 hoist line	Also referred to as AIN6
AIN0	Angle Sensor	
AIN1	Length Sensor	
AIN2	Direction/Friction sensor on main hoist	
AIN3	Direction/Friction sensor on auxiliary hoist	

**ERROR I**

Errors I comes from low voltage input. Use a voltmeter and verify the power supply voltage. The minimum acceptable is 11 volt DC.

**ERROR J AND K**

These errors are caused by a failure of the base board. Replace the base board or send it in for repair. Note where each wire is connected. Note where each jumper and dip

switch is set. If repaired, the system may not need recalibration. If replaced, the system will need recalibration of the sensors.

**ERROR L**

The keypad or the keypad driver is not working at power up. Replace the key pad or try another display board. It is recommended to get technical support.

**ERROR M**

The screen failed to respond to the processor. If the failure is more serious, nothing will appear on the display or the information will be frozen. Technical support or on site service is recommended.

**ERROR N**

The 8255 chip is the driving chip for all the display indicator lights. If there is a spike in the supply or lockout voltage, the 8255 will momentarily reset causing all the lights on the display to light. Adding a diode on the lockout wires to the ground and/or a capacitor on the supply can reduce this. This minor error does not prevent normal system functioning.

**ERROR O, P, Q, R**

Errors show internal memory failure: tech. support or on site service recommended.

**ERROR S**

The system cannot find a chart for the configuration selected. For example, selecting a Pick and Carry and JIB 32FT leads the system to Error S since there is no chart for that configuration. Configure the crane properly.

Another case is where the boom length exceeds the maximum boom length specified in the chart. This can happen if the reeling drum wire sags when fully telescoped. This problem can be resolved by changing the OD-LENGTH value in the calibration mode.

**ERROR T**

This error indicates that the radius was not calibrated for this boom or jib selection. Radius must be calibrated with the boom fully retracted as a minimum requirement.

**ERROR U, V**

These errors will appear when changing CHiPs containing charts and the operating system. The only solution is to re-calibrate the system entirely. This situation will not appear when changing charts and keeping the same operating system.

**ERROR W**

This error appears on calibrating radius and boom moment before completing the dimensions menu.

**8.2 Diagnostic Menu**

**ACCESS**

Press the **DISPLAY** button four times and the screen will show the diagnostic menu.

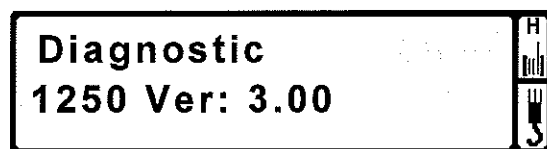
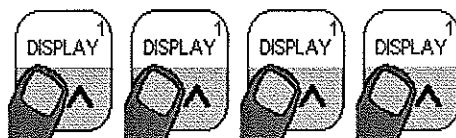

Press button number 8 (**ENTER**) to enter the diagnostic menu. Then press button 3 (**DOWN V**) to scroll down through the various diagnostic informations.

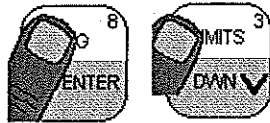

<b>FRAME: F50TI340</b> <b>99/01/01 14:36</b>	
---	--

**VERSION**

This is the operating software with version date and time of issue. This information is important when calling for technical support or making changes in charts or upgrading the operating system. This manual is written for the operating software 1250 Version 3.00, issued March 14, 1999 and after. Operating software 1250L, 1258, 1257, can also be referred to this manual.

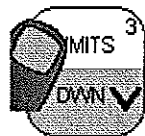

<b>99/01/01 14:36</b> <b>Ain0: 1.70V &gt;.1</b>	
--	--

**ANGLE**

AIN0 is the angle sensor voltage, it must be above 0.1 Volt, 0.3 Volt to calibrate. The exact voltages will vary from one model of angle sensor to another. Refer to your angle sensor specification sheet. The important thing is that there is an increase of at least 1.0 Volt from 0 degree to 70 degrees and that the voltage varies at any angles and never exceeds 4.8 Volts.

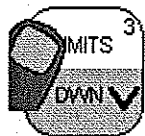

<b>Ain0: 1.70V &gt;.1</b> <b>Ain1: 0.56V &gt;.1</b>	
--	--

**LENGTH**

AIN1 is the length sensor voltage, it must be above 0.1 Volt, 0.3 Volt to calibrate. The exact voltages will vary from one model of length sensor to another. Refer to your length sensor specification sheet. The important thing is that there must be an increase of at least 0.015 Volt per foot and that the voltage varies at any length and never exceeds 4.8 Volts.

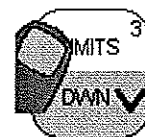

<b>Ain1: 0.56V &gt;.1</b> <b>Ain6: 0.51V &gt;.1</b>	
--	--

**LOAD SENSOR**

AIN6 is the load sensor voltage, it must be above 0.1 Volt, 0.3 Volt to calibrate. AIN6 is the only load sensor voltage available; it can represent the main hoist, the auxiliary, the whip1 or the whip2. The voltage displayed is that of the selected hoist in the operating mode or in the diagnostic mode (see Hoist: 1 = Main on next page).

The exact voltages will vary from one model and size of load sensor to another. Refer to your load sensor specification sheet. The important thing is that there must be an increase of at least 2.500 Volt from no load to maximum line pull and that the voltage varies with any load, even the ball.

For load sensor used with amplifiers see amplifier specification sheet for the voltage input. If the signal is out of range or too low with maximum line pull, see amplifier adjustment in the installation section.

If no amplifier is used and the signal is below 0.25 Volt, the wires may be cut or not connected. If the voltage is above 4.9 Volt with no load, one wire may be cut or open. See load sensor trouble shooting specification.

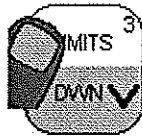

<b>Ain6: 0.51V</b>	<b>&gt;.1</b>	
<b>DR+ : 5.08V</b>	<b>&gt;.1</b>	

**SENSOR SUPPLY DR+**

The DR+ is the sensor supply voltage. It normally indicates 5.05 Volts plus or minus 0.08 Volt. If the voltage is below 4.90 Volts, a sensor wire is shorted causing a drain of power. If the voltage is above 5.25 Volts, a load sensor wire is damaged or the internal amplifier is set incorrectly causing the load sensor voltage to increase above 4.95 Volts. A wrong DR+ will affect the readings on all sensors.

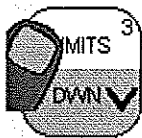

<b>DR+ : 5.08V</b>	<b>&gt;.1</b>	
<b>HSI0 : 3610 (Hz)</b>		

**HSI**

This value is not necessary to understand. The HSI0 is the high precision input for the load sensor. Just like AIN6, the HSI0 is used for all the load sensors. Instead of using a voltage input into the processor with a raw resolution of 1023 increments, the HSI, which stands for High Speed Input, uses a frequency conversion. Combined with the microprocessor's micro second timer, the frequency can be timed into 2100 increments while using only 60% of the signal. Once the raw resolution is averaged and filtered, a resolution of 4000 increments with reading stability and fast response is achievable. Unfortunately, for the operator's ease of reading, much less resolution is used with this software version.

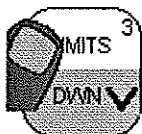

<b>Bit</b>	<b>0</b>	<b>1</b>	<b>2</b>	<b>3</b>	<b>4</b>	<b>5</b>	<b>6</b>	<b>7</b>	
<b>Din:</b>	<b>0</b>	<b>1</b>	<b>1</b>	<b>0</b>	<b>0</b>	<b>0</b>	<b>0</b>	<b>0</b>	

**DIN (DIGITAL INPUTS)**

Din stands for Digital Input. There are 8 digital inputs or commonly called switch inputs. Only four are readily available on the terminal strip of the control unit.

Bit stands for the address or name of each digital input. The numbers 0 and 1 next to Din stand for the status of each input. 0 means ground (0V) and 1 means positive (VP) for example, Din 0 is ground, Din 1 is positive, Din 2 is positive and Din 3 is ground. When the terminal is left open, it defaults to the supply voltage 12 or 24 Volts (VP) and a 1 is displayed. When the terminal is grounded (0V), it displays a 0. Note that this is the standard setting; each or all of the input switches can be reversed to default to 0V instead of VP.

Digital input 0 is used for the Anti-Two-Block. When unconnected, the terminal defaults to 1 causing the A2B alarm and lockout to activate.

Digital input 1 is used for the main slew switch. When grounded, it usually signifies over front or over rear. If the charts are included in this manual, you will notice that when Din1 is 0, selection 1 for slew position is used in the chart. When Din1 is 1, selection 0 for slew position is used in the chart.

Digital input 2 is used for special programs. One example is a man basket application where the man basket is bolted to the boom. When this switch is ground, the system no longer relies on the load sensor input for the displayed load. Instead it uses a fixed value set during calibration and selects a specific chart for man basket operation.

Digital input 3 is used for bypass activation and when grounded, showing 0 on the screen, the operator can use the **BYPASS** button to override the lockout and external alarm.

All the digital inputs positive source comes from the VP terminal. The VP terminal is used for powering switches, proximity switches and external amplifiers only. The VP or Voltage Positive is a fused power supply source. The fuse for VP is the lower one in the control unit. If the fuse blows, all digital inputs turn to 0. Therefore, the two-block alarm will be on, the over side capacity chart will be used, the hook load will show the man basket value or 0.0 and bypass will be available.

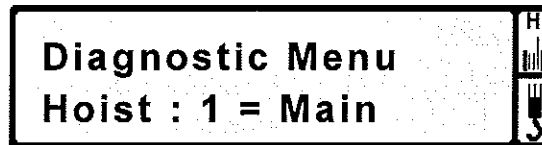
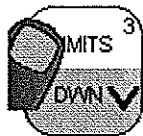

**HOIST**

This is a quick access to the hoist selection while in the diagnostic mode. Use the **SET** buttons to change hoist and verify the voltage input on AIN6 and the HSI input. Changing hoist here will change the hoist in the operating mode but not the parts of lines and the configuration. Using the **HOIST** button in the operating mode will reestablish the proper settings.

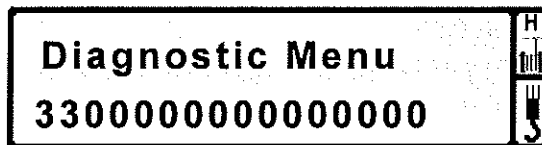
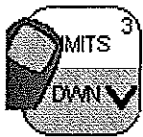

**CALIBRATION**

On this screen, a number occupies every bottom space. Either 0, 1, 2 or 3. The bottom spaces represent the boom configuration from 1 to 16 starting from the left. For instance, the left most number represents the main boom configuration.

Each different number indicates the status of the radius calibration for the specific boom configuration. 0 indicates that this boom configuration radius is not calibrated. 1 indicates that P1 and P2 are calibrated. 2 indicates that P3 and P4 (no load deflection) are calibrated. 3 indicates that the loaded boom deflection has been performed.

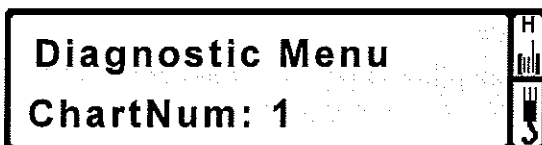
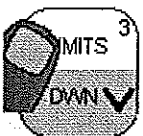

**CHART NUMBER**

This is the chart number. For programming use only.

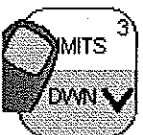

**BINARY CHART VALUE**

This value is used only during programming of charts.

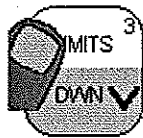

**Diagnostic Menu**  
**SH555001.SRC**



### FILE NUMBER

This is a file number containing the programmed charts. If any problem with selection of charts, selection text and capacity value occurs, refer to this file to verify and make the corrections. This file is kept by the local manufacturer's office where the system originated.

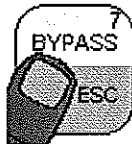

Press ESC to return to the primary display. You can press the ESC button at any point while in the diagnostic mode to return to the primary display or press the UP button to view previous information.

## 9. ROUTINE MAINTENANCE

### CLEANING

Do not pressure or steam clean the control box, junction boxes, angle sensor, load cells and any connectors. This could force moisture in the connectors and cause sensor failure in time. To clean the display's surface use mild soap or mild window cleaners. Use a clean/soft cloth.

If cleaning the dynamometer, dismantle the load cell and wipe clean with a cloth. Use of a solvent is not recommended on a loadcell. The dynamometer can be soaked in solvent. Change the bearings if contaminated or clean thoroughly and re-grease. The bearings are standard 6005 or 6006 and are relatively easy to replace.

### WIRES

Verify all the wires for cuts or damages. Replace if needed.

### DYNAMOMETER

Grease all the grease nipples every three months or every 500 hrs. Verify that the sheaves are turning freely. Verify that all bolts are tight .

### DISPLAY

If condensation appears in the display of the control unit, open the cover in a dry place and let air dry for a day. When perfectly dry, tighten slightly the cable glands. Apply silicone grease of similar material to the cover seal and re-tighten the cover. Do not over tighten as this would localize the seal pressure and void the waterproof quality of the seal.

### PERFORMANCE CHECK

Verify the accuracy of the system every day and every 6 months or 1000 Hr. See next section: Performance Check for accuracy requirements and procedures.

## 10. PERFORMANCE CHECK

### DAILY

Before or at the beginning of every shift, configure the system properly and verify the weight of the hook block with every hoist, the radius with the boom selection used, the angle and the capacity. See section below for tolerances.

### EVERY 6 MONTHS

Perform a complete periodical test. Position and level the machine. Testing personnel must be familiar with the machine and the system. The crane and the system must be configured properly. The load chart must be respected.

One known weight accurate to +/- 1% and equal to the maximum capacity at near maximum radius will be used to test the alarm and the accuracy of the load indication.

Another known weight accurate to +/- 1% and equal to the maximum capacity at near minimum radius will be used to test the alarm and the accuracy of the load indication.

Use the periodical test sheet included to record information such as owner's name, the crane manufacturer, crane serial number, system model, system serial number, crane configuration at time of test, system configuration at time of test, location of the load sensor, a statement that the system meets the requirements, signature of the person testing, etc.

Rig with enough parts of lines to lift the large weight. Fully retract the boom and boom up to the maximum, measure and record the radius, the hook weight and the angle. Note the displayed angle, radius, length, hook weight, parts of lines and capacity. Lift the large weight. Record the actual weight with the hook and rigging attachment. Note the displayed weight after performing a hoist down and stop. Note the average, the low and the high value. Perform a hoist up and stop and note the same data. Boom down slowly until the alarm sounds. Note the actual and displayed radius. Put the load down.

Rig with enough part of lines to lift the small load. Telescope out fully and boom down to 45 degrees. Measure and record the radius, the hook weight and the angle. Note the displayed angle, radius, length, hook weight, parts of lines and capacity. Lift the small weight. Record the actual weight with the hook and rigging attachment. Note the displayed weight after performing a hoist down and stop. Note the average, the low and the high value. Perform a hoist up and stop and note the same data. Boom down slowly until the alarm sounds. Note the actual and displayed radius. Put the load down.

### ANGLE

The angle displayed on the indicator must be between zero and two degrees below the actual angle.

### LENGTH

The displayed length must be between zero and one foot longer than the actual boom length.

### RADIUS

The displayed radius must be between zero and 10% greater than the actual radius.

### LOAD

The displayed weight with the load must be between zero and 10% greater than the actual load. For the hook block, the weight must be between zero and 200 lbs of the actual hook block weight.

**PERIODICAL TEST SHEET**

Owner's name		
Crane manufacturer		
Crane serial number		
System model		
System serial number		
Crane configuration at time of test		
System configuration at time of test		
Location of the load sensor		
Signature of the person testing		
Test date		
Statement that the system meets the requirements:		
	<b>Minimum Radius</b>	<b>Maximum Radius</b>
Actual Radius		
Displayed Radius		
Difference		
Percent		
Actual Boom Length		
Displayed Length		
Difference		
Percent		
Actual Angle		
Displayed Angle		
Difference		
Actual hook weight		
Displayed Hook Weight		
Difference		
Actual capacity		
Displayed Capacity		
Difference		
Actual test weight + rig + hook		
Displayed Hst Dwn average		
Displayed Hst Dwn high		
Displayed Hst Dwn low		
Displayed Hst Up average		
Displayed Hst Up high		
Displayed Hst Up low		
Difference		
Percentage		
Load moment alarm Radius		
Allowed actual radius		
Difference		
Percent		



REFERENCE TABLES

The following tables were presented previously in this manual. They are reproduced here for fast reference purpose.

Control Wiring

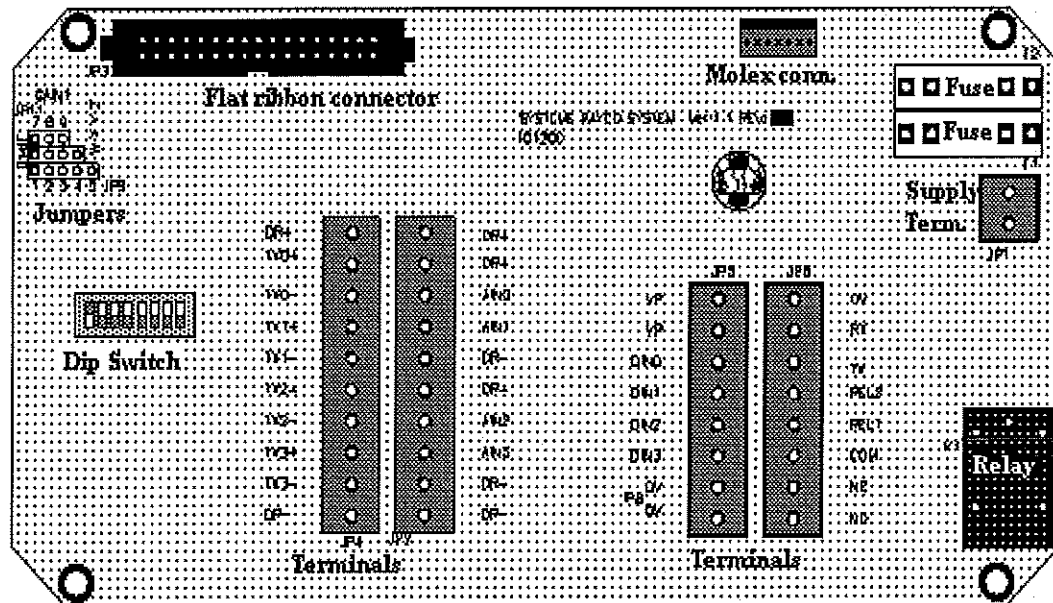

Din Description

- 0 Anti-two-block
- 1 Used for Duty Selection from slew switch
- 3 Used for special duty selection when needed
- 4 Used for Motion Cut Bypass

Ain Description

- 0 Boom Angle
- 1 Boom Length
- 2 Direction sensor main hoist
- 4 Direction sensor aux. Hoist

TX Description

- 0+ Positive signal of the load sensor on main hoist
- 0- Negative signal of the load sensor on main hoist
- 1+ Positive signal of the load sensor on aux. hoist
- 1- Negative signal of the load sensor on aux. hoist
- 2+ Positive signal of the load sensor on whip1 hoist
- 2- Negative signal of the load sensor on whip1 hoist
- 3+ Positive signal of the load sensor on whip2 hoist
- 4- Negative signal of the load sensor on whip2 hoist

**Dip Switch**

SWITCH	STANDARD	REASON
Dip switch 1:	ON	Always on
Dip switch 2:	OFF	Always off
Dip switch 3:	OFF	Always off
Dip switch 4:	OFF	Always off
Dip switch 5:	ON	Off only if a fourth load sensor is installed
Dip switch 6:	ON	Off only if a third load sensor is installed
Dip switch 7:	OFF	Only if AUX. load sensor has a 4-20 mA input
Dip switch 8:	OFF	On only if main load sensor has a 4-20 mA input

The dip switch box is located on the INPUT BOARD:

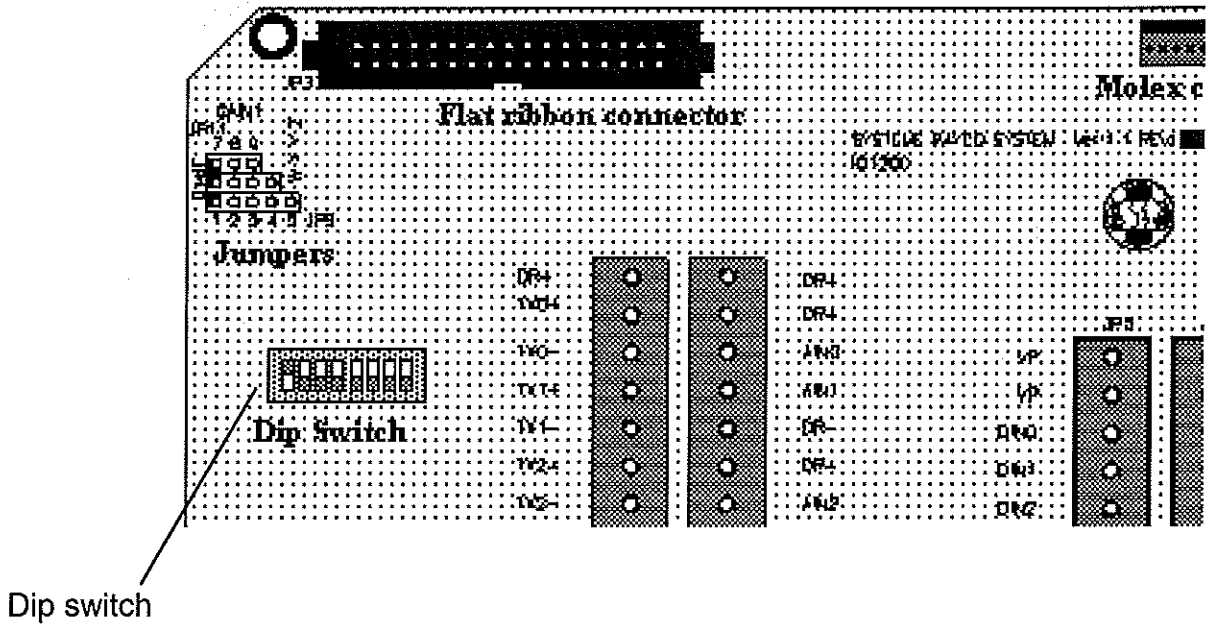

Internal Amplifier

Configuration	Connections	Gain
	No Connection	1
	1-2	100
	W-X	200
	7-8	500
	1-2, 3-4	125
	1-2, 3-Y	137
	1-2, 3-Y, 4-5	186.5
	W-X, 2-3	250
	W-X, 3-4	333
	W-X, 4-Z	375
	7-8, 4-Z	624
	7-8, 3-Y, 4-Z	688
	7-8, 4-5	831
	7-8, 2-3, 4-5	1000



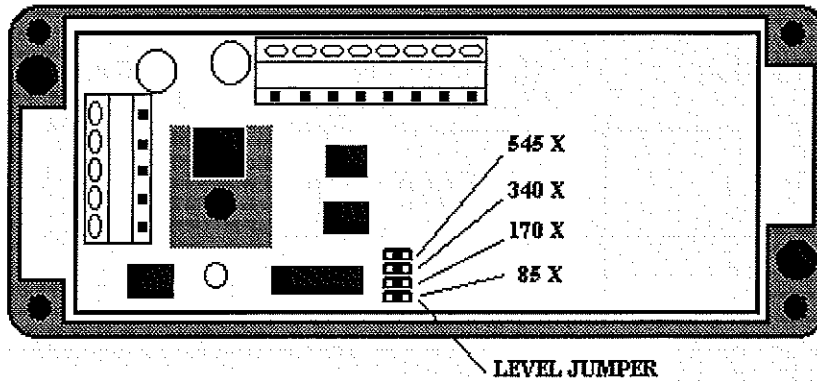





**External Amplifier**



**Key Board**

Button	Key	Name	Description
	1	Display Scroll up	Selects additional display screen like length, height, error report, dimmer, diagnostic
	2	Hoist Set >	Pressing the button toggles to the next hoist and selects the crane configuration last associated to the selected hoist
	3	Limit Scroll down	Select the limits variables for display and setting with buttons 2 and 4
	4	Parts Set <	Pressing the button toggles to the next number of parts of lines for the selected hoist
	5	Boom Jib	Pressing this button displays the boom selection and then, automatically toggles to the next boom configuration for the selected hoist
	6	Config Deduct	Pressing this button displays alternately the selected tire/outrigger configuration and the selected deduct. Use button 2 and 4 to change them. Or, if only 1 field to select from, it toggles to the next selection automatically.
	7	Bypass Esc	Pressing this button bypasses the lockout momentarily. This button will bring back the main screen anytime.
	8	Rig Enter	Pressing this button below the set-rigging angle will bypass the lockout until the rigging angle is exceeded. This button confirms a new setting and returns to the main menu.

**Indicator Lights**

Symbol	Warning Light Functions
	<p>This light flashes with the audible alarm on when the load is between 85% and 99% of the rated capacity.</p>
	<p>This light will illuminate to warn the operator when the load is over 100% of the rated capacity. The lockout will be activated</p>
	<p>This light indicates two-blocking. If there is a lockout, it will be activated</p>
	<p>This light will illuminate when an Out of Limit condition is detected by the system. This condition occurs on a low/high angle limit, max/min length limit, max. radius limit, or a max. height limit set by the operator.</p>
	<p>This light indicates that the displayed maximum load is limited by the hoist Rope. Increasing the parts of line will extinguish the indicator light.</p>
	<p>This light indicates that a jib has been selected as the boom selection. Roosters are also considered as jibs.</p>
	<p>This light indicates, when an over end/rear/front duty is present, that the boom is over that section and the superior rated capacity is displayed. This light only works when a slew switch is installed.</p>
	<p>This light indicates outriggers fully extended and down have been selected in the configuration by the operator.</p>

**Error Code**

	<b>DEFINITION</b>	<b>CODE</b>
<b>Failure due to sensor</b>	A	Failure in sensor TX0
	B	Failure in sensor TX1
	C	Failure in sensor TX2
	D	Failure in sensor TX3
	E	Failure in sensor AIN0
	F	Failure in sensor AIN1
	G	Failure in sensor AIN2
	H	Failure in sensor AIN3
<b>Failure due to Board (I/O)</b>	I	Failure due to low battery
	J	Failure in DR Plus
	K	Failure in HIS Time-out
<b>Failure due to Display</b>	L	Failure with keypad
	M	Failure with LCD display
	N	Failure in 8255 chip
<b>Failure due to Memory</b>	O	Failure - Eprom busy
	P	Failure - Checksum Eprom
	Q	Failure - Checksum EEprom
	R	Failure - Checksum RAM
<b>Failure due to chart</b>	S	Failure - No duty Chart
	T	Configuration not calibrated
	U	Failure - Checksum Chart
	V	Failure - Invalid value detected
	W	Dimensions missing



